

DOCUMENT RESUME

ED 110 393

SO 008 536

AUTHOR Donovan, Dorothy J.
 TITLE Voter Education. A Resource Manual for Teachers and Students.
 INSTITUTION Institute for Political/Legal Education, Pitman, N.J.
 PUB DATE Mar 75
 NOTE 120p.; Related documents are SO 008 534, 535, and 537
 AVAILABLE FROM Institute for Political and Legal Education, Box 426, Glassboro-Woodbury Road, Pitman, New Jersey 08071 (\$7.50)

EDRS PRICE MF-\$0.76 PLUS POSTAGE. HC Not Available from EDRS.
 DESCRIPTORS American Government (Course); Case Studies; Civil Liberties; Community Cooperation; *Elections; *Law. Instruction; Learning Activities; Manuals; News Media; *Political Science; Politics; Resource Materials; Role Playing; Secondary Education; Simulation; Voter Registration; *Voting; *Voting Rights

ABSTRACT

This material is produced to provide a program to instruct secondary level students in the political, governmental, and legal processes and to encourage active student participation in these processes. The materials draw heavily upon community cooperation as a base for practical learning. Part of a year-long curriculum, this unit focusing on voter education examines the process of issue analysis, canvassing, and registration with insights into media publicity and propaganda techniques, and election strategies. Voting reform, rights and procedures, party structure, and the electoral college are intensively examined. Chapter one introduces the permanent vote education organization which, when fully implemented, functions as part of the course dealing with elections and campaigning. The second chapter contains a variety of curriculum activities to fully incorporate the goals and objectives of the unit. Activities include a mock election, coffee parties, and receptions, among others. The voter education retrieval system is explored in chapter three, which examines the various methods to increase voter registration and turnout. Several appendices and a bibliography conclude the document. (Author/JR)

 * Documents acquired by ERIC include many informal unpublished *
 * materials not available from other sources. ERIC makes every effort *
 * to obtain the best copy available. nevertheless, items of marginal *
 * reproducibility are often encountered and this affects the quality *
 * of the microfiche and hardcopy reproductions ERIC makes available *
 * via the ERIC Document Reproduction Service (EDRS). EDRS is not *
 * responsible for the quality of the original document. Reproductions *
 * supplied by EDRS are the best that can be made from the original. *

VOTER EDUCATION

ED110393

U.S. DEPARTMENT OF HEALTH,
EDUCATION & WELFARE
NATIONAL INSTITUTE OF
EDUCATION

THIS DOCUMENT HAS BEEN REPRODUCED EXACTLY AS RECEIVED FROM THE PERSON OR ORGANIZATION ORIGINATING IT. POINTS OF VIEW OR OPINIONS STATED DO NOT NECESSARILY REPRESENT OFFICIAL NATIONAL INSTITUTE OF EDUCATION POSITION OR POLICY.

PERMISSION TO REPRODUCE THIS COPYRIGHTED MATERIAL BY MICROFICHE ONLY HAS BEEN GRANTED BY
Barry E. Lefkowitz

TO ERIC AND ORGANIZATIONS OPERATING UNDER AGREEMENTS WITH THE NATIONAL INSTITUTE OF EDUCATION. FURTHER REPRODUCTION OUTSIDE THE ERIC SYSTEM REQUIRES PERMISSION OF THE COPYRIGHT OWNER.

W.G. WILKES



IPLE

00002

50 008 536

JUL 10 1975

INSTITUTE FOR POLITICAL AND LEGAL EDUCATION

VOTER EDUCATION

A RESOURCE MANUAL FOR TEACHERS AND STUDENTS

Prepared by

Dorothy J. Donovan
Administrative Assistant

March 1975

Copyright © Institute for Political and Legal Education, Educational Improvement Center, Pitman, New Jersey, 1975. Copyright will be claimed only during the period of further development unless copyright of final materials is authorized by the New Jersey State Department of Education.

On behalf of the Department of Education, State of New Jersey, I wish to bring the Institute for Political and Legal Education to the attention of educators throughout the nation. The program has made a significant contribution to the education of high school students about the American political, governmental, and legal processes and thus should be of interest to educators, parents, and students.



Dr. Fred G. Burke
Commissioner of Education
State of New Jersey

00004

The Institute for Political and Legal Education was developed through the cooperative efforts of the Institute staff, educators in local New Jersey districts, and the staff of the Office of Program Development, Division of Research, Planning, and Evaluation/Field Services, the Department of Education, State of New Jersey. The political and legal materials were developed between 1971 and 1974 with funding from Elementary and Secondary Education Act, Title III:

In 1974, the political education program was validated as successful, cost-effective, and exportable by the standards and guidelines of the United States Office of Education. As a result the program is now funded through ESEA, Title III as a demonstration site to provide dissemination materials and services to interested educators.

00005

INSTITUTE FOR POLITICAL AND LEGAL EDUCATION

ADMINISTRATIVE STAFF

Barry E. Lefkowitz, *Director*
Dorothy J. Donovan, *Administrative Assistant*
John F. Khanlian, *Assistant to Director*
Katherine L. Wallin, *Associate Assistant*

EDUCATIONAL IMPROVEMENT CENTER STAFF – LEA

Paul Winkler, *Executive Director*

Project Address

Institute for Political and Legal Education
P.O. Box 426
Glassboro-Woodbury Road
Pitman, New Jersey 08071
(609) 589-3410

ACKNOWLEDGMENT

The Institute for Political and Legal Education would like to extend a special tribute to Dr. Lillian White-Stevens of the Office of Program Development, New Jersey Department of Education, for her fine professional editing of this curriculum guide.

IPLE Staff

Dr. Fred G. Burke
Commissioner of Education
State of New Jersey

STATE BOARD OF EDUCATION

Mrs. Marion Epstein, <i>Vice President</i>	Princeton
Bryant George	Teaneck
Mrs. Ruth Mancuso, <i>President</i>	Glassboro
Mrs. M. Patricia O'Hara	Butler
Allen G. Potter	Branchburg
Jack Slater	Paterson
Mrs. Helen A. Zehner	Woodstown
Mrs. Katherine Neuberger, <i>Representative of Board of Higher Education</i>	Lincroft

Secretary, Dr. Fred G. Burke, Commissioner of Education

EX OFFICIO

Gilbert G. Roessner, *Chairman*
Board of Higher Education

Ralph A. Dungan, *Chancellor*
Department of Higher Education

New Jersey Department of Education

Dr. Ralph H. Latajle	<i>Deputy Commissioner</i>
Dr. Gary Gappert	<i>Asst. Commissioner of Research, Planning, and Evaluation</i>
Dr. William Shine	<i>Asst. Commissioner of Curriculum and Instruction</i>

TABLE OF CONTENTS

	Page
PREFACE	xvii
INTRODUCTION	xx
Chapter,	
I. Permanent Voter Education Organization	1
Introduction	1
Voter Education Campaign Calendar	3
Ad Hoc Committee	5
Research Committee	5
Student Assistance Committee	5
Publicity Committee	5
Finance Committee	8
Registration Committee	8
Advisory Committee	8
II. Curriculum Activities	9
Election Information Center	9
Contact Committee	9
Coordinating Committee	10
Communications Committee	10
Issue Analysis Center	15
Campaign Registration Center	19
Organization	19
Canvassing Techniques	27
Simulation Election	31
Election Chairperson	31
Selection of Parties	31
How Candidates Run	32
Election Day Activities	32
Financing	33
Political Education Assembly	35
Types of Political Assemblies	35
Planning an Assembly	36
Campaign Activities	39
Campaign Headquarters	39
Group Assistance	39
Telephone Campaign	40
Coffee Parties and Receptions	40
One Out of Five Technique	41
Media Publicity Techniques	41
Campaign Materials	43
Board of Elections Observation	45
Subtle Bias in the Media	47
Introduction	47
Prime Location	47

Chapter

Page

Spacing	49
Pictures	49
Headlines	51
Interview Articles	52
Conclusion	53
III. Voter Education Retrieval System	55
Statutes	55
Introduction	55
Election Definition	56
Procedures for Filing for Office	56
Committees, Boards, and Challengers	56
Voter Registration: Qualifications/Procedures	58
Sample Ballots and Voting Procedures	61
Electoral College	63
Introduction	63
Historical Design of the Framers of the Constitution	63
History of the Latest Resolution	64
Analysis of the Resolution	64
Defects of the Present System	65
Minority Report: Senate Committee	66
Recent Reforms Defeated in Committee	66
Party Structure	69
Introduction	69
Organization	69
APPENDICES	
A. Press Release	79
B. Political Party Platform	81
C. Student Questionnaire on Campaign Staff	83
D. "How to Lose an Election"	85
E. Voter Registration Form	87
F. Nomination by Petition for Primary Election Form	89
BIBLIOGRAPHY	
A. Human Resources	91
B. Organizational Resources	99
C. Suggested Readings	101
D. Audio/Visuals	103
E. Simulations	103

"Always vote for principle, though you may vote alone, and you may cherish the sweetest reflection that your vote is never lost."

— John Quincy Adams

"The future of this republic is in the hands of the American voter."

— Dwight D. Eisenhower

"You can milk a cow the wrong way once and still be a farmer, but vote the wrong way on a water tower and you can be in trouble."

— John Fitzgerald Kennedy

"There can no longer be anyone too poor to vote."

— Lyndon Baines Johnson

PREFACE

A new constituency has been created in America following ratification of the 26th Amendment to the United States Constitution which lowers the voting age to eighteen.

Surveys across the nation of students approaching the age of eighteen have revealed similar and disappointing results. The majority of high school students do not know their local, state, or federal representatives; do not know how to register to vote, do not understand the Bill of Rights, and express disillusionment and frustration with the system.

There is an obvious need for an awareness and understanding of the political, governmental, and legal process. The logical approach for correcting the situation is education within the school system.

The function of the Institute for Political and Legal Education (IPLE) is to provide a program to instruct secondary level students in the political, governmental, and legal process. Through IPLE, students demonstrate a significant positive increase in their knowledge and reveal an inclination to participate actively in the political process and law-related fields.

A unique feature of the program lies in the view of the total community as a classroom since it attempts to utilize all resources in the community and State as a real and practical base for learning. Students are out of school approximately thirty-five days per school year, involved in field study and internships. Working in the community provides students, through experiential learning, an opportunity to apply the skills acquired in the classroom. This can be accomplished at the local, county, and/or state levels.

Through surveys, problem solving, issue analysis, research, simulations, field study, and interning, students eventually possess the ability to initiate projects which affect their community in a positive manner.

The year-long curriculum is subdivided into three areas of concentration, alterable by the interests and selections of the students and teacher. An integrated combination of innovative informational and instructional manuals is utilized within each unit of study, along with simulation games, surveys, projects, audio/visual materials, and appropriate interning. In addition, individual classroom, regional, and state-wide training conducted by professional experts provides participants with an active overview of the unit.

The *Voter Education* unit includes the process of issue analysis, canvassing, and registration with insights into media publicity/propaganda techniques, and election strategies. Voting reform, rights and procedures, party structure, and the electoral college are examined intensively. An optional political assembly and simulated election are highlighted with historical review, candidate speakers, and local party campaigning. Activities which are encouraged during the unit include a voter registration drive in and out of school; campaigning for actual candidates (working in campaign headquarters, telephone canvassing, door-to-door canvassing); working as challengers at an election; organizing transportation and/or babysitting for election; and conducting survey polls for election in and out of school.

The *State Government* unit examines the structure and function of the state, county, and local levels, intertwined with previous unit issues such as environment, housing, and transportation. Included are policy formation, lobbying, media techniques, sociological surveying, and value orientation. Simulation gaming is used for the purpose of revealing to the student the decision-making process of governmental bodies. In

addition, students learn the operation of intergovernmental communication and are provided with a practical knowledge of labor-management relations. Student awareness of the passage of laws not only is experienced in out-of-school interning at the State Legislature and/or a professional lobbyist's office but also is simulated at a three-day Model Congress.

The *Individual Rights. Freedom of Expression, Fair Trial v. Free Press* unit concentrates on the freedom of speech (including expression) and fair trial v. free press as intricate parts in the study of the court system, criminal procedures, and the basic foundations of law. Case studies are presented, e.g., *Roth v. United States*, *New York Times v. Sullivan*, whereby students analyze the decision rendered. Students are expected to formulate their own law, evaluate its precision, jurisdiction, limits of enforcement, and possible alternatives. Included is the *Mock Trial. Tinker v. Des Moines*, a simulation activity where students assume roles of individuals associated with this freedom of expression case. Students learn, through role playing, the process of a District Court evidentiary hearing and a Supreme Court session. Field study or interning might include the Bar Association or the Public Defender's Office.

Activities and projects throughout the curriculum have been designed to provide students at lower, middle, and upper ranges of ability the opportunity to overcome challenges at their appropriate level. In this way, more flexibility is afforded to the teacher in selecting curriculum options.

The key to IPLE's popularity with students, teachers, administrators, and community leaders is its foundation in the real world of political action. Students do not watch an election from the sidelines they are a part of it! They do not memorize the names of Supreme Court justices they actually see the court system in action!

INTRODUCTION

The basic tenet of American politics lies in its participatory nature. Full participation can only be reached when there is complete understanding and knowledge of the political, governmental, and legal process.

The *Voter Education* unit is the first in a series of three units of study comprising a year-long social studies curriculum. This manual is designed to provide students with practical experiences in the area of canvassing, registration, campaigning, and issue analysis via a series of activities, simulations, projects, and field study.

Students' opinions are continually encouraged in an atmosphere conducive to free interaction, thus stimulating further self-investigation. The overall objective of this unit is to increase the students' understanding and participation in the political process.

Pre-planning will increase the effectiveness of each section of the manual in conjunction with local, state, or national elections. Since the teacher cannot be expected to manage a variety of simultaneous activities, this curriculum is designed for student coordination. Workshops and interning activities are encouraged as critical elements in teacher-student participation.

PERMANENT VOTER EDUCATION ORGANIZATION



00014

CHAPTER I

PERMANENT VOTER EDUCATION ORGANIZATION

In order to conduct an effective voter education effort, a stable base should be established which will guarantee a permanent and comprehensive voter education project. The Permanent Voter Education Organization (PVEO), when fully implemented, functions as part of the course dealing with elections and campaigning. In addition, it can continue to serve as a viable institution, active and rejuvenated by a new group of students each year.

The effectiveness of a permanent voter education organization depends upon the degree of information and awareness obtainable by the students as members of a community. A model PVEO operates in harmony with the composition of the school, considering the differences associated with vocational, commercial, general, and academic programs.

The purpose of this section is to provide the teacher and students with an overview of the Permanent Voter Education Organization committee structure and responsibilities. It is suggested that constant reference be made to other sections of the manual, where indicated.

The PVEO consists of a basic committee of six individuals. It is suggested that these include the president or representative of the study body, a liaison appointed from each of the sophomore, junior, and senior classes, the chairman of the social studies department, and a designated representative of the teacher association or union. These members are responsible for the overall coordination of the program and the ad hoc committees of research development, student assistance, publicity, finance, and registration.

It is important that the teacher establish a timeline for voter education activities to ensure that all may be adequately completed in proper sequence. The calendar should then be distributed to all members of the organization.

VOTER EDUCATION CAMPAIGN CALENDAR

The voter education campaign calendar is a timeline check list relating to voter registration activities. Students should use this chart to monitor general progress and important deadlines.

1. Fill in the key legally fixed dates

Utilizing a calendar, fill in those dates which are fixed by statute and thereby represent a legal deadline for party activities. These dates should be noted on the calendar in an outstanding manner so as to designate their importance.

- _____ Candidate filing
- _____ Registration dates for primary and secondary elections
- _____ Special ballot request and return
- _____ Primary and general elections

2. Fill in the dates relating to implementation of voter registration (PVEO)

- _____ Organization PVEO meeting
- _____ Appointment of committees
- _____ Establishment of election information center
- _____ Completion of community contacts
- _____ Appointment of volunteers
- _____ Voter identification drive
- _____ Mock election staging
- _____ Political education assemblies
- _____ Return of canvassing data
- _____ Scheduling of candidate interning
- _____ Securing of challengers
- _____ Arrangement for transportation for voters
- _____ Establishment of campaign headquarters
- _____ Approval of annual budget
- _____ Fund-raising programs

AD HOC COMMITTEES

Research Committee

The Research Committee accumulates information for registration drives, surveys, and issue analyses. The responsibilities of this committee are to:

- Obtain factual data about voter registration procedures in the county
- Disseminate facts obtained to other PVEO members
- Identify unregistered voters by means of a survey or records check
- Identify and distribute information on candidates' background and position on issues.
- Obtain a permanent campaign headquarters (room or office in the school, filing cabinet, etc.).

The election information center activity, (pages 9-14) can provide the committee with information concerning candidates and issues, and assist in the distribution of this material to the students. Canvassing techniques, when adequately developed, from the instructions on pages 27-29 will provide identification of unregistered and previously registered voters.

Refer to election information center, pages 9-14, canvassing, pages 27-29, and campaign activities, pages 36-43.

Student Assistance Committee

The *Student Assistance Committee* organizes student volunteers to participate in various political activities. Assistance should be solicited from existing organizations (student council, class government, etc.) for enlisting interested student volunteers. The responsibilities of this committee are to:

- Compile a card file of volunteers, noting names, addresses, telephone numbers, special skills, and time available for service
- Brief volunteers as to the purpose of voter registration and basic electoral participation, through information supplied by the Research Committee
- Organize interested volunteers to work with community political parties or organizations
- Provide a means of recognition to the volunteers for their work—a party, an award, a notice in the newspaper.

Publicity Committee

The *Publicity Committee* acts as a public relations unit to inform the public about voting, candidates, and election issues. Persons with creative ability in writing and art would be desirable for the committee to seek. The responsibilities of this committee are to:

- Contact the media to promote voter registration activities
- Decide on appropriate publicity tactics such as posters, public service announcements, news releases, etc.
- Organize poster contests, debates, or discussions which explain but do not promote topical issues.

Estimated Volunteer Record

	NUMBER REQUIRED	DATE REQUIRED	COMMENTS
Surveying			
Maintenance			
Publicity			
Research			
Personnel			
Telephoners			
Transportation			
Rélations			
Telephoners			
Transportation			
Babysitting			
Telephoners			
Transportation			
Babysitting			
Challengers			
Clerical			
Poll Watchers			
Headquarters			
Electioneering			

VOLUNTEER APPLICATION

Name _____ Telephone _____

Address _____

Age _____

Volunteer has the ability to assist in:

- | | |
|------------------------------------|---|
| <input type="checkbox"/> Clerical | <input type="checkbox"/> Canvassing |
| <input type="checkbox"/> Research | <input type="checkbox"/> Registration |
| <input type="checkbox"/> Publicity | <input type="checkbox"/> Transportation |
| <input type="checkbox"/> Finance | <input type="checkbox"/> Other |

Available on
Election Day
from _____ to _____

Available during the following days of the week from _____ to _____

Monday: from _____ to _____

Tuesday: from _____ to _____

Wednesday: from _____ to _____

Thursday: from _____ to _____

Friday: from _____ to _____

Saturday: from _____ to _____

Sunday: from _____ to _____

Comments: _____

As a publicity device, the simulation election (pages 31-34) provides students with an opportunity to participate in a state, county, and local election, in which the function of a registration drive and the operation of voting machines will become a personal experience. A political education assembly (page 32) is a vehicle for transmitting non-partisan information in an interesting format concerning campaign issues, parties, and candidates. In addition, the publicity committee must consider the advantages of press releases and free coverage in contacting the media. Coffee parties and receptions can assist in establishing a rapport with a large number of constituents.

Refer to simulation election, pages 31-34, political education assembly, pages 35-37 media publicity techniques, pages 41-43, and campaign activities, pages 39-44.

Finance Committee

The Finance Committee establishes a secure monetary base needed to conduct particular activities. The responsibilities of this committee are to:

- Plan and execute fund raising strategies, e.g., car washes, rock concerts, etc.
- Solicit donations
- Allocate funds to other ad hoc committees.

Registration Committee

The Registration Committee is responsible for registering voters for upcoming elections and for insuring that voting procedures are administered properly at the polls. Their specific duties are to:

- Follow the guidelines of the County Board of Elections in general operation, using the appropriate registration forms
- Organize individuals to act as challengers on election day.

In order to operate an effective PVEO the committees must cooperate with the County Board of Elections. County boards usually comply with requests for cooperation in registration plans, including on-site registration in the school, which has now become mandatory in all secondary schools in the State of New Jersey:

"On or before the last day of school on which a person may register to be entitled to vote in the ensuing primary election, the commissioner of registration... shall arrange for and conduct registration in each public and non-public high school in the county, of all students who are eligible to register to vote in the ensuing election."

R.S. 19:21-2

To have students act as challengers at polling places, the PVEO should contact the appropriate individuals in advance to secure their approval for the position. The party is required to file application for challengers no later than the second Tuesday preceding any election.

Refer to the campaign registration centers (pages 19-26) and board of elections observation (page 45).

Advisory Committee

The Advisory Committee (optional) acts only in a supportive capacity to the PVEO and not as a board of directors. Their function is to provide literature, speakers, and training in organizational skills. Suggested individual members for the committee include: Democratic and Republican municipal chairmen; principal or faculty member of high school, and representatives from the League of Women Voters, labor unions, Chamber of Commerce or Jaycees, local government, and ethnic organizations.

CHAPTER II

CURRICULUM ACTIVITIES

ELECTION INFORMATION CENTER

The purpose of the election information center activity is to provide the student population with an awareness and understanding of the candidates and their views. The Center also acts as a guide to political involvement by students.

The Election Information Center should be organized and maintained entirely by students. One student, selected to be the Director of the Center, will coordinate the student volunteers and will be responsible for ensuring that the material, both on the bulletin board and in the folders, is kept up to date. The Director of the Center should be capable of organizing and coordinating activities and numbers of students in a manner that fosters cooperation and initiative among staff members. The chairman of the Center will be responsible for coordinating three committees: the Contact Committee, the Coordinating Committee, and the Communications Committee, each of which selects a chairman to oversee the work and to meet with the Director.

Materials required for the Center include a physical structure capable of housing a visible bulletin board, which will be used to provide up-to-date information to the general public, file boxes with file folders, and tables or desks for boxes and workers. The location of the Center is very important. It should be easily accessible to students, and large enough to accommodate a number of students at one time. Some possible locations are: school hallway, extra room in building, or back of a classroom.

Contact Committee

This committee is responsible for contacting out-of-school sources, namely, the county clerk, located at the county seat, and local political organizations in order to compile two lists of candidates and offices: (1) offices for election and candidates to fill them and (2) local political organizations interested in high-school volunteers.

Some political organizations to contact and to offer student volunteers include the local League of Women Voters, Jaycees, Democratic and Republican parties, labor unions, and ethnic and religious action projects. When contacting the aforementioned groups, students should identify themselves, their school, and the purpose of their project. It is important that students be polite and courteous at all times.

Operating Procedure

1. Contact the school office and find out what cities are represented in the school population.
2. Contact the county clerk's office at the county seat and request the names, party affiliation, and office of all candidates on the ballot in each ward, encompassing all voting districts represented in the school.
3. Contact local political organizations and offer student assistance during the election period.
4. Compile all information into two separate lists:
 - Offices and candidates
 - Interested political organizations.

Coordinating Committee

The main responsibility of this committee is to coordinate student volunteers with local political organizations.

After the list of interested political organizations is obtained from the Contact Committee, the chairman of the Coordinating Committee should appoint one student for each organization to be the liaison between the school and the political organization. The liaisons will each contact their organization, explaining who they are and where they can be reached at home.

After the Center is open, the Coordinating Committee will be responsible for taking the names and phone numbers of the student volunteers at the Center. Forms should be printed for volunteers to fill out. If the students have a preference to work for a particular organization, this should be honored. If the student has access to a car, this should also be noted. A possible form would read as follows:

Name _____
Address _____
Telephone _____
Preference: Yes No
If Yes _____
Access to car: Yes No

The students of this committee should be willing to man the Center and to register volunteers. They should also advertise the opportunity for political activity through posters.

Operating Procedure

1. Obtain lists from the Contact Committee.
2. Chairman assigns one person per organization as liaison.
3. Make advertising posters; print registration forms.
4. Compile list of volunteers and keep up to date.

Communications Committee

This committee, the largest of the three at the Center, maintains a complete up-to-date data bank on all candidates, including their party affiliation, employment experience, views, and policies. Such data are compiled and published in a weekly report which is distributed to the general public. This information can be obtained from the candidates' local headquarters and from newspapers by using the Candidate Questionnaire and then transcribed onto the Election Profile sheet.

CANDIDATE QUESTIONNAIRE

Name _____ Party Affiliation _____

Address _____

Telephone _____

Occupation _____ Age _____

Education _____

Present Employment _____

Marital Status _____

Spouse's Name _____

Dependents' names and ages. _____

Qualifications for prospective office _____

Motivation for seeking position: _____

Reaction to following questions and/or issues:

Government _____

Education _____

Environment _____

Taxation _____

Student Observer-use only

Reaction to candidate was _____

If it is not possible to visit the headquarters, a letter should be written explaining why the information is requested. The information should include the major candidates' ideas on every issue described in the Issue Analysis Center. Therefore, the chairman will, in many cases, be called upon to determine what is fact and what is rumor. This is to be a non-partisan presentation, all bias remarks should be stricken from the report.

Complete folders on each candidate should be filed at the Center, in alphabetical order, and should include in a concise presentation:

- party affiliation and past employment (elective and non-elective)
- past views and policies
- present views and policies.

This committee also maintains a bulletin board which includes a chart of offices and candidates, current news releases on candidates' views on relevant issues, and a list of interested political organizations as a reference for volunteers. The bulletin board should be a combined effort with the Issue Analysis Center. A model chart which has been organized to comply with any election has been included to assist with the design. Special elections should be noted and included with the various offices up for election in different years.

Operating Procedure

1. Obtain lists of candidates and offices and interested political organizations from Contact Committee.
2. Contact candidates' headquarters for necessary information.
3. Design bulletin board and set up chart.
4. Check newspapers for new views or policies.
5. Compile folders and keep up to date.
6. Distribute information obtained from Issue Analysis Center.

	Democratic	Republican	American 1st	Communist	Socialist Labor	American Independent
President						
Vice President						
U.S. Senator						

	Congressional District #		Congressional District #	
	Democrat	Republican	Democrat	Republican
Congressman				

	Democrat	Republican
Freeholder		

	City	City	City	City
	Democrat	Republican	Democrat	Republican
Mayor				
City Council				
School Board				

Republican Committeeman	
Republican Committeewoman	
Democratic Committeeman	
Democratic Committeewoman	

ISSUE ANALYSIS CENTER

In conjunction with the Election Information Center, the Issue Analysis Center can be started for the purpose of collecting, analyzing, and distributing news releases, emphasizing topics involving political candidates and issues. It serves to educate students in the manner of objective reasoning and to offer insight to the pragmatic operations of electioneering.

The Issues Analysis Center operates around a bulletin board strategically arranged and located in the school building. Its function is to provide information concerning the practical development of campaign issues involved in an election. It should be located in an area with sufficient room for students to examine and discuss issue priorities and bulletin board composition, and should be easily accessible and visible for all students to observe. Once a site is located, the board should be arranged and mounted as follows.

Potential Issues	International	National	Local	State
Issues				
Effect On Campaign	How does this affect the candidate's position?			

A table should be placed under the bulletin board for boxes and file folders in which to store back clippings.

Students should collect articles on a daily basis from international, national, state, and local publications. Some recommended sources for articles are:

1. *New York Times* (international, national, state)

2. Area daily paper (state, local)

3. Weekly local paper (state, local).

Each day the new clippings should be arranged and placed on their respective locations on the board. All old clippings are placed in the file folders which are labeled by subject (war, taxes, ecology, etc.) and placed in cardboard boxes for future references.

A quick glance at the board will indicate that issues and articles are further categorized in terms of *potential issues*, *issues*, and *effect on campaign*. Thus, before students will be able to operate the board, they must learn to differentiate between the different types of articles.

A *potential issue* includes policy statements or press releases from candidates or organizations, editorials, political columnists, and any accusations made concerning the campaign. In short, it is subjects concerning, or anything said by or about, the candidate, political organization, or campaign staff.

An *issue* includes subjects which are *presently* being debated or which have become controversies.

The *effect on the campaign* is the manner in which the candidate reacts to issue development. This is measured in terms of campaign tactics and strategy alteration.

To decide whether something is an issue or potential issue, you must decide upon the objectivity of its source. The media can, through placement, extent, or content, bias the reader toward a certain point of view. For example, a newspaper supporting a candidate may emphasize something which is beneficial to the candidate but not really an issue, or may be an issue created by the media rather than the candidate. To understand the actual affect of something upon a campaign, it must be viewed in its proper perspective.

To decide whether a newspaper is "slanting" the news, you may wish to follow these procedures:

1. Check the editorial page for acknowledged bias (editorial support, comment).
2. Check the number of feature stories concerning different candidates, and the intensity of these stories.
3. Check the placement of candidates' pictures (i.e., front page as compared to hidden advertisements).
4. Notice the headlines used with pictures and articles (e.g., bold print as compared to small; positive as compared to negative).
5. Most important, watch for the placement and adjective description of regular news stories covering the campaigns.

For example, if candidate A's "exciting" speech appears on page one three times a week, and candidate B's "boring" remarks are hidden on page 13, it would indicate a clear preferential bias of the newspaper towards candidate A.

The Issue Analysis Center should work jointly with the *Communication Committee* of the Election Information Center at all times, providing them with information for the maintenance of the bulletin board.

In addition, the following activities can be used as supplementary classroom work and/or extra curricular activities:

1. Independent studies by students. This involves receiving class credit for doing research papers or discussion groups. Some topics for consideration would be following the development of an issue, comparing and contrasting the way several newspapers treat the same issue, and comparing the effect that two different issues have upon the campaign.
2. Discussion panels by classes which could lead to a panel discussion at a school-wide assembly. This discussion should examine the significance of various issues and could be supplemented at an assembly by filmstrip or slide presentations.

In addition, this panel could be presented to various local civic groups such as the Kiwanis, Junior Women's Club, and Jaycees. This would directly involve the students with the community and at the same time provide community citizens with pertinent election information.

3. Set up committee to make spot announcements on the issues over the public address system in the school each morning. An "issue of the week" could be initiated by the committee.
4. A comparison of weekly news magazines. Students could compare *Newsweek*, *Time*, *The New Republic* and *U.S. News and World Report* for their presentation of the issues and candidates.
5. A pre-test and post-test of student views on the most important campaign issues and candidates. These tests should be concerned not only with presenting facts (e.g. the name of the Democratic Vice-Presidential candidate) but also with determining that the student understands the significance of certain facts (e.g. the choice of a certain vice-presidential candidate from Georgia to appease Southern political leaders, thereby "balancing the ticket").

In other words, pre- and post-test should determine whether students understand the operation of campaign strategy.

6. Student leaders in the class could open discussions of the issues in other classes and share their learning. This, however, should be carefully planned in advance with key questions previously arranged.
7. Compare the Democratic and Republican party platforms either in panel discussion or as a classroom project.
8. Collect and analyze political cartoons and how they relate to the issues.
9. Compare articles from several newspapers on the same event and note how they vary in emphasis and construction. Note side, choice of words, pictures, or other contrasting features.
10. Compare the editorials with the news reported to see if the newspaper slants its reporting to complement the editorial position. This may indicate whether candidates, which agree with newspaper's view, receive preferential treatment in reporting. This is measured in terms of adjectives used to describe the candidate, page and location placement of stories about him.

CAMPAIGN REGISTRATION CENTER

Organization

The basic tenet of American politics lies in its participatory nature. Full participation can only be reached when every person eligible is registered to vote. Voter registration cannot be achieved by itself. It must be instigated by a group or groups.

Establishment of a campaign registration center requires an overall staff coordinator responsible for identifying target district sites, placement of personnel, coordination of transportation and scheduling. In addition, this student is responsible for locating a convenient area for on-site registration by cooperating with the county election board and town clerk. The overall coordinator must represent the organization at a number of meetings covering a wide range of negotiations with local police, city council, and neighborhood associations or political parties.

Overall Coordinator

This person should exhibit active participation in order to foster identification with the organization and a feeling of accomplishment among the members. By assigning individuals responsibilities and by recognizing achievements or contributions, motivated through self-initiative, the coordinator can establish a constructive program.

Sound decision-making requires an ability to recognize real problems as separated from personality conflicts. By setting objectives that are limited in scope and attainable with available resources, members will be willing to accept common goals. Consultation with specialists and personnel will provide the coordinator with the factual data required to distinguish between pertinent and unnecessary input. Such activities necessitate that the organizer have the ability to communicate with courtesy, clarity, conciseness, and completeness.

The duties of overall coordinator are to:

- Decide which of the tentative sites will be the target district
- Choose spot of on-site registration.
- Be liaison between organization and local officials and candidates, police, and media
- Set operational rules and regulations
- Set deadlines and be ready to adjust them accordingly.

Field Staff

The field staff derives their title from the location in that all their activity occurs in the "field." In other words, these are the people who operate the drive in the neighborhood. Over 90 percent of their work is at the neighborhood target areas. All available personnel should be assigned to the field effort.

A field staff coordinator should be selected using similar criteria as in the case of the overall coordinator. The field staff coordinator is responsible for the actual canvass and registration drives and insures continuous communication with the overall coordinator. Personnel must be assigned efficiently, to make sure that target districts are sufficiently covered. Coordination is necessary for transportation teams and babysitting schedules during registration. Manpower must be sufficient so maximum coverage of the district

can be accomplished. As the number of un-canvassed houses *decreases*, the amount of available staff per residence *increases*. Hence, the coordinator will be able to saturate, with added student canvassers, the remaining homes where no response was available.

The duties of the field staff coordinator are to.

- Direct and solve problems at the target district site
- Efficiently assign personnel
- Make sure target district has been sufficiently covered
- Decide when maximum coverage has been achieved
- Coordinate schedules of transportation teams and babysitting teams during registration
- Meet with overall coordinator periodically to avoid coordination breakdown.

Clerical Staff

The clerical staff takes over after completion of the canvass drive conducted by the field staff.

The clerical staff coordinator need not have clerical abilities, but must be able to oversee the operation and make sure that it functions efficiently and properly. After the canvass phase of the drive has been completed, the clerical staff takes the "raw stats," that is the information compiled via the canvass sheets, and converts these to worksheets. These worksheets should include the names, addresses, and telephone numbers of all unregistered voters listed in order by street address. The worksheets will have the tabulated results from the canvass broken down to a block-by-block order so pickup of registrars may be facilitated with a minimum of confusion.

The clerical staff, under the leadership of the clerical staff coordinator, attempts to maintain deadlines and communication with field staff.

The duties of the clerical staff coordinator are to:

- Oversee the preparation of the worksheets from canvass sheets
- Meet all deadlines set by the overall coordinator for his staff
- Communicate with the overall coordinator in order to solve any problems that may hinder staff from meeting the deadline
- Expect and push for 100 percent effort from all staff members.

Selection of Districts

After the staffs and coordinators have been organized, the process of target district selection is begun. Target district selection will require that local and county revised maps be obtained from the board of elections or clerk's office and sites be determined. Advice should be requested from the city clerk to help determine where the concentrations of population are located within the city. The county chairmen of both the Republican and Democratic parties should also be contacted. They may be able to give additional information in this area. Divide the canvass/registration corps into color-coded teams which will correspond to marked areas on the maps and thereby illustrate the progress of the drive. An example of this technique is supplied in the following illustration.

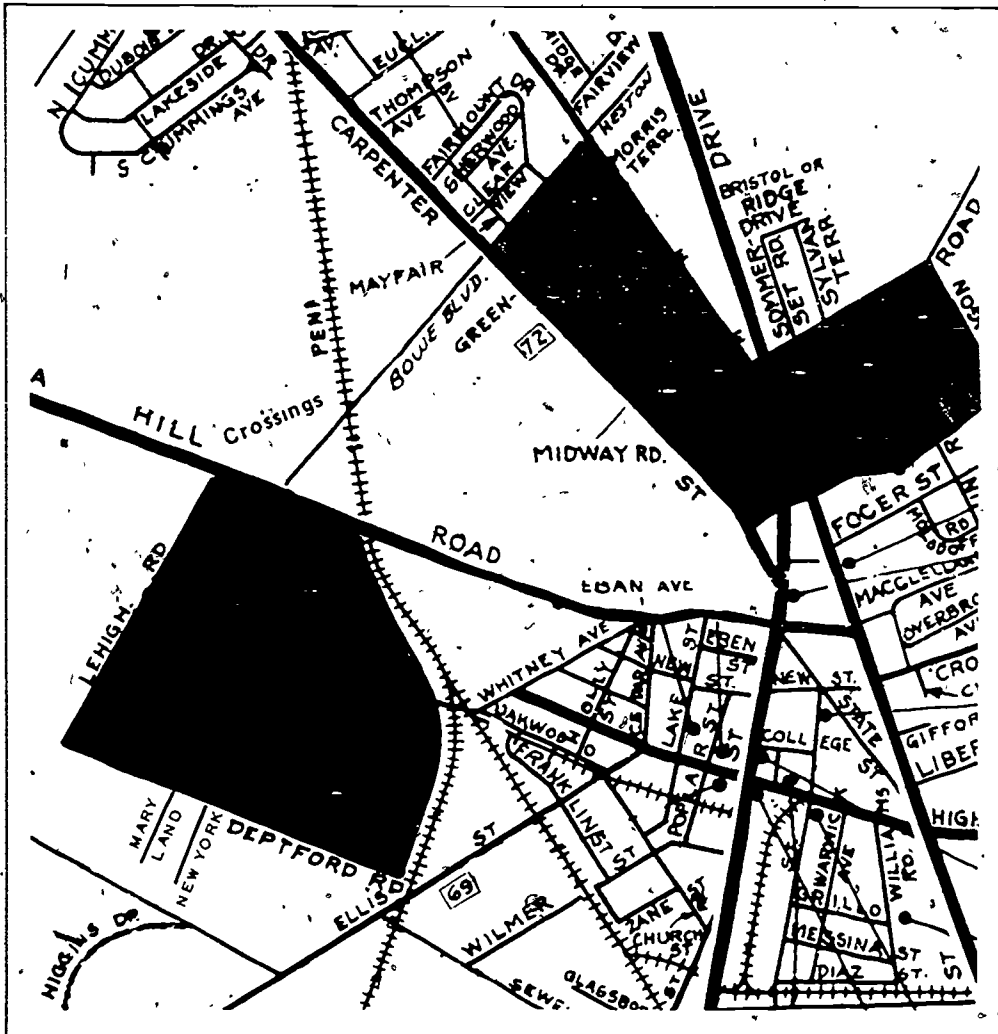

In order to determine the productivity of the district, consider the transportation and manpower needs to geographically cover the district. Note the number of new people in developing areas, the amount of transient residents, and the ratio of unregistered voters to total population of each district. Rural areas are difficult to canvass due to the spaced distribution of housing. Furthermore, it is difficult to locate a registration site convenient to all in the area. Securing registration can be partially solved by providing mobile vans for use in transporting registrars. City apartment layouts are easily and quickly canvassed if a centrally located registration area is announced in advance. City districts provide ideal canvassing since the homes are situated closer together.

Notification

Following selection of districts, notification to the community concerning the program and purpose is helpful. It is important to stress *who* you are, *what* you will be doing, and *when*. Methods of notification should include, *in advance*, mailing of letters or postcards to residents, newspaper advertisements, or radio broadcasts. It is important to secure permission from the police department because of local ordinances governing door-to-door activities and to prevent possible arrest or detention of staff members. In addition, local party organizers and candidates (Republican and Democrat) should be contacted to alleviate any problems and establish a good rapport.

Sample Postcard:

The Institute For Political and Legal Education of
_____ H. S. will be conducting a
registration canvass drive on _____ at
_____ a.m./p.m. Actual registration will
take place at _____ on _____
from _____ p.m. 'til _____ p.m. _____

Thank you,
Students, I.P.L.E.,
_____ H. S.

The following organizational chart is supplied as a device for illustrating the operation of this activity.

ORGANIZATIONAL FLOW CHART

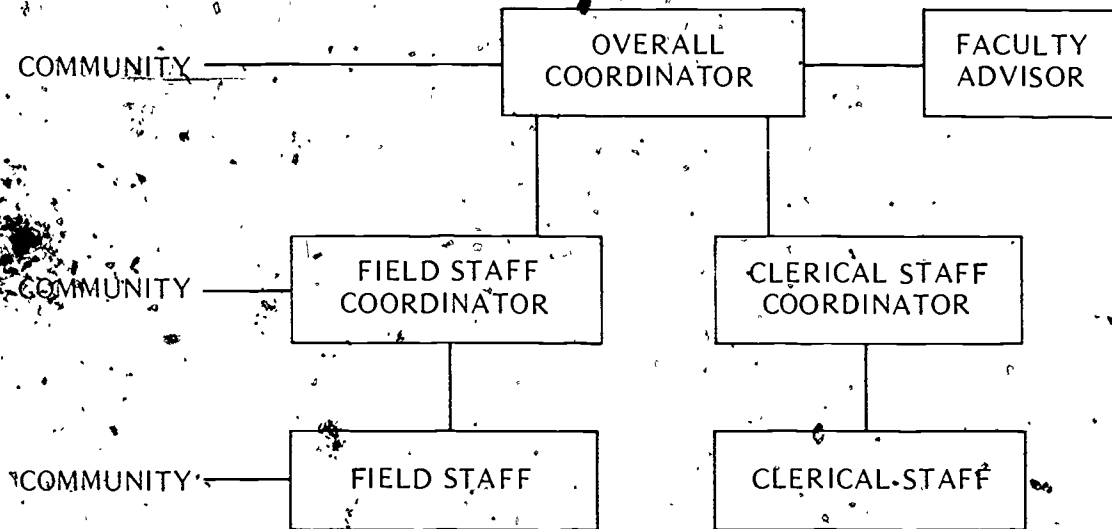

CANVASSING TECHNIQUES



00036

Canvassing Techniques

Procedure

Community canvassing includes the essential elements of introduction, delivery, and follow-up to insure success. An effective procedure always involves the following: knock, carry a clipboard with all vital voter details, and proceed with, "Good morning (or afternoon). I'm (name of person), from _____ High School as part of the Institute for Political and Legal Education, and we are canvassing _____ community. Would you mind answering these *brief* questions?" Request their name, address, telephone number, and if there are any unregistered voters in the household (especially 18 year olds). If there are unregistered voters, ask whether they need transportation or babysitting service. Lists of eligible voters and sometimes unregistered individuals are available through the local political parties, especially committeemen or women or the board of elections. Revised Title 19 voting laws state

In each county the commissioner of registration shall submit to the Secretary of State, on or before February 15 of each year, a plan providing for evening registration for the primary election, and on or before July 1, plans for evening and mobile registration. Such plan for mobile registration may include door-to-door registration and shall include the schedule and route to be followed by the mobile registration units. On or before the last school day on which a person may register to be entitled to vote ... the commissioner of registration ... shall arrange for and conduct registration in each public and non-public high school in the county, of all students who are eligible to register to vote in the ensuing election. School officials shall cooperate with efforts to register students in such schools.

R.S. 19.31-2

The following is a suggested listing of *community canvassing techniques*. Students should recall that an effective canvassing campaign is effective if it is properly organized and carefully presented to the public.

1. Introduce yourself and state the name of the organization you represent.
2. Note any services requested or unanswerable questions.
3. Explain the importance of voter registration and the significance of electing representatives to government.
4. Be courteous and neat in appearance.
5. Avoid arguments and lengthy discussions.
6. Mark on a list any resident not available during canvassing in addition to those assisting in transmitting the information.
7. Carry sufficient literature, but do not convey the impression of a bill collector or vendor.
8. Canvass between the hours of 4:00 and 9:00 p.m. on week days and full days on Saturday and Sunday. Inclement weather is excellent since it keeps residents indoors.

SAMPLE: CANVASS SHEET

I. Name: _____ Address: _____ Phone: _____ _____	Remarks: (For example) • Not home • Return later
II. Are you registered or not? Yes _____ No _____ Will anyone else in the house be of Voting (a) _____ Age on or before Election Day (b) _____	
III. Needed. Change of Address Card? Yes _____ No _____ Ride _____ Babysitter _____	

Following the canvass, it is important to compile the worksheets from the canvass sheets as *quickly* and efficiently as possible. The clerical staff can assist in maintaining worksheets by name, address, and telephone number (noting unregistered voters) and need for transportation or babysitting service. Note that transportation should involve one car with driver and a male/female. Babysitters should be individuals living as close to the person's neighborhood as possible so that the parent feels more comfortable leaving the child. Survey teams should consist of a male and female, a combination that puts most people at ease.

Prior to community canvassing, participants should investigate the motivation of individuals to vote in an election.

A panel of students should assume the roles of various character types such as a policeman, labor union member, a stockholder of IBM, etc., in order to analyze voter habits and reasoning. Factors influencing the individual voter would include the significance of an election, the impact of the outcome, particularly in areas of high single party concentration, and the comparative costs of voting and non-voting.

Simulation

In order to prepare for canvassing in the community this activity should be introduced to the student by means of a simulation. Generally, if objectives are formulated in advance by the instructor, the method of presentation will be easily translated into a simulation.

Start with two people (one on one) and define the setting as simply as possible with a minimal amount of props. For example, place a chair or table between two students to differentiate the inside from the outside of a house. Build on the opening segment by adding a variety of character types such as conservative, liberal, sophisticated, cooperative, or hostile individuals. In response to all these types, please impress on the canvassers

1. Keep cool and calm.
2. Be polite.
3. Don't waste time making converts.
4. Answer any questions they might have *politely*, but stay off the "soap box"; no speeches!

Observe the manner in which the canvasser approaches the resident and note improvements. Incorporate "alter egos" of pro and con attitudes towards voting to influence the characters being portrayed. Note as the individual hesitates for a second in between sentences in their response, the canvasser should *quickly* interject with another question. An example of this format follows

Canvasser. Would you mind answering some brief questions?

Alter Ego. Tell her you're busy with the children.

Resident. I'm sorry, my children are keeping me very busy.

A few basic rules of thumb should be followed.

1. Start the students *one on one* on the role play
2. Add different type characters (i.e., Archie Bunker, sophisticate, etc.)
3. After one on one then use alter egos.
4. Have students reverse roles (this is done so that the student becomes cognizant of the arguments both for and against the person wanting to register or vote)

SIMULATION ELECTION



SIMULATION ELECTION

The purpose of a simulation election, or "mock" election, held in school is to provide students with an awareness not only of the mechanisms of political campaigning but also of the election rules and laws. As a learning technique, this activity offers students participation in a state, county, and local election in which the function of a registration drive and the operation of voting machines are presented and experienced.

Election Chairperson

The election chairperson is a non-partisan student moderator-coordinator responsible for the liaison coordination of the election process. The student will work closely with the faculty advisor to guarantee that the most expedient and least confusing methods of party selection, informative assemblies, and registration of voters are employed.

Negotiations with local officials in advance will be necessary for the elected student candidates to participate at government offices. Most communities are willing to arrange for students to serve a day in office. The respective official should be approached by the election chairperson and faculty advisor in advance to secure their cooperation. The importance of students as members of the community participating in government should be stressed. Explain that their cooperation in allowing the student to observe and act with them in their daily functions is an experience needed by youth and will be an excellent means for good public relations with the community. Further note in detail the outline of the simulation election activity and educational and administrative benefits.

It is the option of the coordinator to conduct both an introductory assembly on the activity, and a second one on the parties, candidates, and platforms. Contacts with Democratic, Republican, and independent election candidates and experts must be achieved in advance for in-school presentations.

The election chairperson must notify the Board of Elections via telephone and mail requests for voting machines as far as possible in advance of needing them. Most Board of Elections will not allow the use of machines after the middle of October in order to prepare them for November election.

Selection of Parties

The next procedure is the designation and definition of two or more prospective party organizations. This can be done in a variety of ways. Two general suggestions are:

1. Divide the group arbitrarily into "Party A" and "Party B."
2. Select two people similar to team captains and have them, in turn, select their co-workers from the group.

A party caucus or meeting is then convened to determine a chairperson and co-chairperson of the party, and a party name. The party name is both a policy-representative and public relations instrument.

The chairperson should, in some manner acceptable to the majority, appoint five committees: screening, board of elections, campaign-publicity, registration, and platform. For a basic understanding of the organization and workings of political parties, refer to Party Structures, pages 69-77.

Screening Committee

Possible candidate positions are as follows. board of elections, councilman, mayor, county sheriff, surrogate, county clerk, freeholders, assemblyman, and state senator. The number of people for some offices is dependent upon the county organizational structure. After investigating the duties of each position, the committee should solicit and screen candidates from the student body in order to get as many of the student body involved as possible. Screening criteria may include ability to present and defend platform, personal appearance, availability, etc.

Board of Elections

The Board of Elections shall consist of selected individuals from each party responsible for counting the votes, enforcing voting statutes, settling disputes, and, in general, expediting the mechanics and activities of Election Day.

Campaign-Publicity Committee

Responsibilities of this committee include the planning of strategies in presenting both the candidates and parties. Fliers, pamphlets, press releases, speech-writing, assemblies, etc. are part of the many functions of this committee.

Registration Committee

This body, comprised of students from each party, must register the student population for the upcoming election in adherence to revised voting laws. A specific time and area should be designated for voter registration. Only individuals who are registered in advance may vote. Canvassing of homeroom districts is reserved for platform or publicity organizations. For a prototype of a voter registration form, see page 87.

Platform Committee

This committee organizes the party platform which should detail the position or opinion of candidates and the party on various issues. Issues are those of the upcoming local or state election and not of the school. A sample platform which may be used as a prototype model is contained in the Appendix, page 81.

How Candidates Run

A coordinated effort by both the campaign and publicity committees helps to create and build a favorable image for their candidates. This can be achieved via articles in the school newspapers, posters in the hallways, informative fliers, and political announcements on the public address system. As much of the student body as possible should be involved.

Rallies for the candidates prior to their formal introduction is a good method of generating enthusiasm for his or her candidacy. Play up the themes of the parties; such as, for the "Realistic Approach to Politics" or RAP Party, use posters and spot ads saying, "... the RAP man is coming!! ..."

Election Day Activities

These involve the election board and registration committees. During a specified period of time on a designated day, students who are registered will be able to vote. Tables should be set up with posted signs containing letters of the alphabet (i.e., A-M; N-Z). Students are instructed to go to the appropriate table, according to their name.

The voting method will be that customarily used in the community, namely, paper ballots or voting

machines. At least six people should be in attendance where the election is being held, as well as someone from the election board, should any problems arise.

After the final vote has been registered, the election board official indicates how the votes are to be tabulated. There must be at least one person from each party (school election board) present when tabulating the votes.

Financing

An optional financing organization may be established. Each student can be allotted a fixed *maximum* amount of "play money" which can be given to either party. A financial report depicting both receipts and expenditures must be published. The party alternately can be designated an amount by the board of elections and audited by the same. In either case, the board of elections should establish a cost listing for certain activities and items.

Contained below is a sample board of elections' cost listing and a political party financial report.

Board of Elections Cost Listing

Item	Price
Posters (4' x 6')	
-located near cafeteria	\$ 1.00
-surrounding main entrance	1.50
-first floor50
-second floor75
Buttons (2" diameter)50
P.A. announcements (30 seconds)	30.00
Assembly (30 minutes)	325.00
Rally (60 minutes)	150.00

Political Party Financial Report

To date these are the official receipts and expenditures of our party:

Expenditures	Receipts
<u>Mayor</u>	
10 buttons \$ 5.00	Faculty \$ 25.00
2 posters 3.00	Homeroom 106 10.00
	Homeroom 108 10.00
<u>Governor</u>	Student Council 300.00
5 posters 2.50	Clerical Staff 20.00
50 buttons 25.00	Freshman class 100.00
1 announcement 30.00	
<u>Remaining candidates</u>	
100 buttons 50.00	
5 posters 5.00	
1 assembly 325.00	
TOTAL \$445.50	\$465.00

In order that the operation of the simulation election run smoothly, some further suggested activities are enumerated below:

1. Each committee person should be responsible for registering each person in his designated district. Canvassing or polling of these grade-level or homeroom districts, should start early.
2. Platforms should be attractive to the majority and published in their final stage.
3. Candidates should be screened by the selection committee on the basis of ability to sell the party platform, speaking talents, etc.

POLITICAL EDUCATION ASSEMBLY

The purpose of a political education assembly presented in the high school is to provide a means for transmitting non-partisan, or bi-partisan, information in an interesting format concerning campaign issues, parties, and candidates. It is a method to help students make responsible decisions as concerned citizens and mature voters; it is *not* a method whereby students are to be manipulated for support or defeat of any political issue or candidate.

Types of Political Assemblies

There are basically two different types of political education assemblies: (1) the informational assembly and (2) the motivational assembly. These may further be categorized in terms of. (a) persons who have been invited to attend, (b) scheduled time of presentation, and (c) determination as non-partisan or bi-partisan.

Informational Assembly

The purpose of this assembly is simply to provide information on all aspects of various issues. It usually deals with three general categories:

1. *The mechanics and regulations of voting*

Operation of voting booths, presentation of registration and voting statutes, and examination of the local party system are possible topics.

2. *Political issues*

The development of an issue, its effect upon the community, and the candidates' views, can be presented (e.g., ecological projects, equal rights, governmental economic problems).

3. *Candidates*

Objective, factual information (not a debate) regarding candidates' credentials, past voting records, and previous achievements is presented by the candidates, party representatives, or an impartial researcher.

Methods of presentation for an informational assembly might include filmstrips, recordings, oral presentations, verbal exchanges, distributed fact sheets, and, in cases such as operation of voting machines, actual physical demonstrations by individuals, such as the superintendent of elections. A successful informational assembly will probably include a combination of these methods.

Motivational Assembly

This type of assembly is designed to initiate action by students, such as registering, voting, or a debating activity allowing audience inquiries and participation. Its function is not to influence students regarding a specific candidate or issue, but to motivate them to evaluate both sides of an issue and then take a position as responsible citizens. It is extremely important that an equal number of representatives is provided for each candidate or opinion and that the moderator remain neutral.

Regardless of the classification, the coordinator of the activity must evaluate the function and type of the presentation and the audience composition.

Further Clarification of Assemblies

The terms non-partisan and bi-partisan are constantly used when referring to political activities. A non-partisan event is free from political party affiliation, whereas a bi-partisan event is representative or composed of two political party associations. Thus, an assembly on ecological projects which includes expert scientists, businessmen and researchers, is likely to be non-partisan whereas a debate of candidates running for a political party would be bi-partisan.

We can further categorize different assemblies according to invited audiences and scheduled time of presentation. If you were conducting an assembly on voter registration, you might wish to invite only seniors, or only those students eligible to vote in the next upcoming election. Furthermore, you might wish to schedule your assembly in accordance with a time schedule that would be most convenient for students to attend without disrupting lesson plans or exams.

Planning an Assembly

There are several major criteria which should be considered during the developmental and dissemination phase of an assembly. The coordinating staff should determine the intended function of the assembly (to inform or to motivate), the type which will best implement the proposed purpose; the audience required to achieve the desired goal, the amount of planning time necessary for successful coverage, and the individuals who must receive prior notification. In determining the purpose, consideration must be given to the motivational or informational aspects of the program. It is only after the function of the assembly has been decided that a logical choice can be made regarding speakers. The audience should receive some immediate beneficial effect from the presentations by being continually bombarded with a variety of speakers, questions, audio-visual techniques, etc.

Preferably, the entire student body, faculty, and staff should be invited to the program. Radio public service announcements of 15-30 second duration can serve as a pre-assembly advertisement. Note briefly the time and place of the activity, distinguished guests, topics to be discussed and the name and purpose of your organization. Some schools have been very successful in setting up candidate assembly programs with local radio stations covering the program as a debate between the candidates. However, due to the limitations of time and physical space, audience attendance may be restricted. In this case, consider which portion of the population will best utilize the information by transforming it into measurable action on a long-term basis.

For example, if you were conducting an assembly on voter participation and had only room for 500 students out of a student body of 1,500, you would logically select, as a first priority, registered voters and potential eligible voters. Then you would invite seniors, then juniors, sophomores, and freshmen. There might be an 18-year-old junior who should be invited as well as a 17-year-old senior.

In order to obtain permission and scheduling, notification of guests, school personnel, and administrators should be accomplished three-to-six weeks in advance to avoid conflicts with school exams or other events. It may be wise also to invite members of established organizations and political parties in the community.

The coordinator should contact the various political party experts and candidates concerning speaking engagements. Potential community and political speakers have their own daily schedules, which are usually set well in advance. You should allow for a very minimum of six (6) months advance invitation. To secure a voting machine requires a vote of approval by the County Board of Elections. They meet once monthly and also have a previous schedule of appointments. Again, in such cases allow a minimum of six months notification.

If possible, schedule with *secured* dates and sites all assemblies one year in advance. This is not very difficult and further, many school districts require that all assembly dates be confirmed by mid-September.

Extra-curricular assemblies, so titled because they occur after normal school hours or outside school property, require additional planning to avoid conflicts with family schedules so as to ensure maximum audience. Consideration must be given to police security measures, safety requirements, accessibility, interference with scheduled events, maintenance, and technical assistance.

If the assembly is to have real significance, it should be supplemented with planned activities (preferably measurable) and a follow-through activity which should relate directly to the content of the assembly. For example, an assembly on voter registration should be followed by a voter registration rally and drive. An exact report, including the number of students registered and voted should later be compiled to measure the effectiveness of the project.

The process of planning a successful assembly and follow-through becomes a reality when implemented in an orderly, logical procedure.

The following procedural checklist for a political education assembly should be adhered to during the planning and dissemination phases of the assembly.

Select general topic by committee (six months-one year in advance)

Determine type of presentation

Present proposed program to proper administrative personnel

Select and confirm site and date (six months-one year in advance)

Select, invite, and confirm distinguished speakers (four months-one year in advance)

Arrange for security (police)

Notify school administration, faculty, and student organizations (six months-one year in advance)

Arrange agenda structure (six months-one year in advance)

Secure audio-visual and additional equipment

Initiation of publicity (press releases and posters, one month in advance for mandatory attendance of students, six months in advance for voluntary attendance and extra-curricular assemblies)

Finalize audience attendance, speaker presentations, etc.

Present assembly

Send "thank you" correspondence

Develop, prepare, and distribute evaluation report.

Refer to Media Publicity Techniques, pages 41-43.

CAMPAIGN HEADQUARTERS



CAMPAIGN ACTIVITIES

Campaign Headquarters

A campaign headquarters is an effective device for centralizing voter education activities. Assistance is required to obtain the physical structure to house the Center and may be solicited from the following sources:

Party Personnel

- County party chairman
- Municipal party chairman
- Local party councilmen
- Local party committeemen

Contact should be made with sympathetic store owners, businessmen, or landlords of vacant stores to help in either securing a location or deferring costs of securing the site. When preparing the headquarters be sure to maintain an organized appearance by avoiding over-saturation of public relations posters and gimmicks, and by keeping the place clean. Arrange a volunteer staff, neat in appearance and capable of courteously and considerately greeting the public, answering their questions, and disseminating campaign literature. The Center should publicize its operations, noting the central phone number, hours (10:00 A.M.-5:00 P.M., Monday through Saturday; 9:00-10:00 P.M. as Election Day draws near—from second week in October on).

"... There is no worse cardinal sin that to keep 'banker's hours' during a campaign for any office ... Irresponsible and lazy staff people can destroy a campaign ..." - Robert F. Kennedy

As an alternative to a permanent headquarters, residential homes can be used as temporary coordination centers. By placing a candidate's poster and a sign noting the use of the home as a campaign post, an entire block can function as a unit. This approach is beneficial where a candidate wants to provide a grassroots image campaign.

Group Assistance

Various organizations not only can lend financial assistance, which is often needed, but can also provide public endorsement through sponsorship, alone or jointly with other groups, of newspaper advertisements. People are greatly influenced by an ad which is signed by groups or individuals that are respected in the community.

The organization may, as a group, vote to contribute financial support; if not, it may still be possible to get significant campaign assistance from individual members of the organization. If a group will release its membership list, a special mailing stressing the campaign issues that are most likely to win their support should be sent to them. Valuable campaign volunteers may be recruited through such groups as these.

It will help to keep a card file of special interest groups in the area including such information as: the institution's name and purpose, number of members; names, addresses, and telephone numbers of officers; dates and location of regular meetings; and campaign issues which interest members. Major groups to contact include the following:

Labor-Central Labor Council; COPE (AFL-CIO); Teamsters DRIVE; UAW's Community Action Program, etc.

Business Organizations-Board of Trade, Chamber of Commerce, etc.

Black Groups-Urban League, CORE, NAACP.

Women's Organizations-Business & Professional Women; AAUW, garden clubs, auxiliaries of service and civic clubs, etc.

Veteran Groups-American Legion, VFW, Disabled Veterans, etc.

Professional Organizations-American Bar Association, National Bar Association, American Medical Association, etc. (scientists, educators, CPA's, nurses, social workers, engineers, architects, may all be included.)

Farmers-Rural Electric Cooperative, Farmers Co-op, National Farmers Union, National Farmers Organization, Dairymen's League of Milk Producers Association, etc.

Youth Groups-Student associations of local high schools and colleges, YMCA, YMHA, YWCA, YWHA, Catholic Youth Organization, Future Farmers of America, etc.

Telephone Campaign

A telephone campaign is the best means of reaching the most voters in the shortest time. It can enlist the assistance of those persons restricted to the home, such as housewives and retired people, and it provides supplemental aid either to canvassing volunteers or to informing the public about the candidate.

Telephone volunteers should always be polite and courteous and attempt to answer all questions immediately or else promptly return the call with sufficient information. It is important that telephone volunteers not call anyone at their business number. Make sure that calls are also not made before 9:00 A.M. or after 10:00 P.M. or at mealtime. These are hours which will bring about a negative response to a call.

The best strategy in using telephone volunteers is to place them in geographically strategic locations throughout the community. Someone who identifies himself as a neighborhood resident will tend to have more effect upon the person receiving the call. It is the psychology of familiarity in this particular case. All conversations should be short, lasting no more than a couple of minutes. An example of one type of call would be:

Good evening Mrs. Dann, I'm Josephine Billings from Euclid Street. I'm calling to let you know that as a member of the community I am concerned about the same problems that are facing our township. I think that you will find that Daniel Smith has the background and experience that prepared him to deal with our problems. We hope you will vote for him for City Council on November 5. Thank you.

Coffee Parties and Receptions

Coffee parties and receptions can assist in establishing a rapport with a large number of constituents. They are especially helpful in local campaigns where the candidate can afford to spend an hour meeting twenty or thirty people. Appoint a chairperson responsible for recruiting hostesses for parties in a specific area. Several such gatherings can be scheduled during the day, spaced so as to allow sufficient time for the candidate to present his/her views, and then move on to the next party.

The coffee party host or hostess is responsible for inviting the guests. She should be encouraged to invite her neighbors and friends, and should plan on having light refreshments—coffee and doughnuts or cookies. Expenses should be minimal, and, if possible, assumed by the hostess.

The candidate should arrive after the guests have assembled, speak personally to each individual, address the group with a brief informal talk, and answer a few questions. In order to provide continuous campaign reception arrival and departure schedules, the following cyclical format is suggested:

1. Advance staff member arrives to inform hostess of time of candidate's arrival.
2. Candidate, campaign manager, and public party liaison arrive. Hostess introduces candidate.
3. Advance man departs to next reception.
4. Following the candidate's *brief* presentation and questions (thirty minutes), the campaign manager and candidate depart.
5. Public party liaison staffer remains to answer necessary inquiries and to record names and addresses, especially of persons interested in becoming campaign volunteers.

One out of Five Technique

The one out of five technique is a method of giving wide coverage in a short time to a candidate during a campaign. The staff should selectively introduce him or her and, in many cases, themselves to residents within a specified district. The strategy here is to introduce the candidate very briefly to neighbors by describing his qualifications and some of his positions. When the candidate leaves, the staff should then be prepared to answer any questions that the person may have. This is also a good time to hand out fliers or other material to the community. Psychologically, the resident has a more positive reaction to the candidate by receiving the material directly rather than in the mail.

Time should be carefully judged to enable the candidate to visit as many homes as possible. By his visiting every fourth or fifth house on a street, neighbors will communicate the candidate's message and the fact that they received a personal visit from his campaign staff. This schedule will *best* utilize the individual's time and provide the illusion or impression that the candidate or his staff is visiting every citizen.

Media Publicity Techniques

A political campaign is an expensive undertaking; therefore, free *press coverage* is an excellent vehicle for public relations. A press secretary should be appointed to coordinate all public relations activities. A person with extensive professional or practical experience in public relations, newspaper, or television work is preferable.

To insure proper placement of news releases, the staff should develop a familiarity and rapport with reporters and editorial personnel. Investigate the publishing schedule of the newspapers, type presented and emphasized, the type of visuals used such as photographs, charts, graphs, and sketches.

Try to determine the editorial policy of the paper (liberal, conservative, leans toward one party or another) and audience (make-up of community reading that particular paper). Businesses and industries with interest in the surrounding community often print an inter-office publication, which can be used for releases.

In order to avoid a hostile press, give direct answers to inquiries; maintain appointments promptly; adhere to 10:00 A.M. press handout deadline; and never instruct qualified reporters or photographers in the intricacies of their profession. In addition, attempt to ascertain the media's requirements necessary to provide

maximum display and impact. For example, know the form in which newspapers and radio and television stations want publicity submitted; know the kind of stories that the media want to feature.

It is important to note, however, that competition, more often than inadequate communication, may dictate where the story finally appears. A "two-line filler" item on local campaign issues or a quote concerning politics can still be an effective reminder to the public. Moreover, the comics or sports section has been under emphasized in comparison to the first page. Front page news consists generally of fast-developing events, such as campaign rallies or visiting celebrity speeches. As a last note, news that receives the best coverage is normally submitted in advance of publication deadlines. It is important to develop a keen sense for what is news. Help "create" favorable news by providing the media with ideas for interesting articles, pictures, and television interviews.

A general format for a news release requires that all entries be complete, concise, simple, direct, and provocative. In addition, articles should be typed double-spaced on 8 1/2 x 11 inch white paper. In the upper left corner type the reporter's name, organization title, phone number, and mailing address. Indicate in the upper right, the release date desired. Typing on the first page should begin approximately one-third of the way down to allow headline material, and, if content extends for additional pages, type "more" on the bottom.

Photographs, if selected properly, can enhance the quality of the article and portray instantly the message. However, publication or management policies may avoid visuals connected with certain topics. Every effort should be made to obtain special coverage of unusual events like campaign dinners and rallies. To increase the chances of receiving special coverage, follow these rules:

- Be sure the media has advance notice of the event. The press covers numerous events throughout the community; therefore, they need to schedule their time in advance.
- Provide the press with free tickets to the event. Do not expect the press to pay to cover your dinner or rally.
- Provide the special facilities the media needs to cover your event. Arrange for a press table. Make sure that lighting and electrical outlets are adequate for filming.

In addition, provide adequate physical arrangements for professional photographers. Amateur entries should be a black and white 3 x 5 inch (minimum size) glossy, void of captions, except on separate attachments. Visuals of the same event should include a variety of horizontally and vertically composed shots of not only individuals or groups actively involved, but also setting or atmospheric pictures.

The following principles are suggested for formulating and distributing news releases:

1. State the main factual material or lead in the opening paragraph with elaboration following immediately.
2. Utilize familiar words.
3. Use short, condensed sentence structure.
4. Avoid useless wording, but remain accurate, factual, truthful, and complete.
5. Be objective, avoid unnecessary adjectives, and provide all necessary times, locations and persons.

6. Write in the third person, avoiding technical jargon, and observe active voice.
7. Identify individuals with their full name and position especially when attributing quotes.
8. Use 8½ x 11" white paper; type on one side (double spaced with ample margins); place name, address, and telephone number of sender at top left side; place date sent and release date at upper right.
9. Indent paragraphs at least five spaces, leaving at least two inches at the top for headlining.
10. Never divide a paragraph when proceeding to the next page—single space if necessary.
11. Place "more" at the bottom of each non-final page and "30" or "##" on the last page.
12. Write "add" plus one less than the page number on each additional page, in conjunction with a word or phrase (slug) at the top for identification purposes.
13. Write "OK" or "cq" above names or unusual spellings to indicate they are correct.
14. Accept the inevitable fact that the original article will not appear as written because of editorial alterations.
15. Remember that photograph captions should be concise, noting the names and positions of the pictured individuals. Photographs enhance a publication, if selected carefully.

For a sample press release, see Appendix A, page 79.

Television and radio coverage is effective because of the personalized environment it can create. A television studio allows thirty or forty-five second, one minute, or one-minute fifteen second, public service announcements. To avoid nervousness in the participants and apprehension by the video controller, arrive prior to the crew and have an accurately typed and timed presentation. An excellent public service message exhibits action by the use of slides, films, graphics, or actors. Discuss with the station the color of the set and the placement of audio equipment. Color videotape requires individuals to wear brightly-colored clothing that does not blend or match a backdrop. Avoid using multi-color, thinly striped, or pure white apparel (white is a "hot color" that gives off a halo effect).

Radio public information messages should be submitted in advance in a concise and detailed form that does not exceed 30 seconds. If the release would be more valuable as a news item, follow the procedure described previously with an air time limit of 15-30 seconds. Telephone conversations can be substituted for news releases, especially if participants cannot be present at the radio station. It must be reiterated that every attempt should be made to establish a personal rapport with the reporters covering your community or the political belt. Established contact with media representatives will give you tremendous advantage although media people will not admit to this.

Campaign Materials

Campaign materials may assume many forms:

A basic *leaflet* provides all essential information concerning the candidate in short, comprehensive terms. A 2 x 3 inch *card* with picture, name, and office is useful for mass distribution. A *litter bag* is not only functional, but provides excellent advertising advantages. *Bumper stickers* are miniature billboards, if they are bright, attractive, and easily readable. *Campaign buttons* manufactured from plastic or metal range from 1¼ to 2 inches in diameter. *Lawn signs*, less expensive than large billboards, give the appearance of good "grass roots" or "ground swell" support, when placed on the lawns of many homes.

Although the materials or gimmick may assume any form, the most important thing is that people see the candidate's name.

The chart below gives a graphic view of the organization of the campaign staff.

Campaign Staff

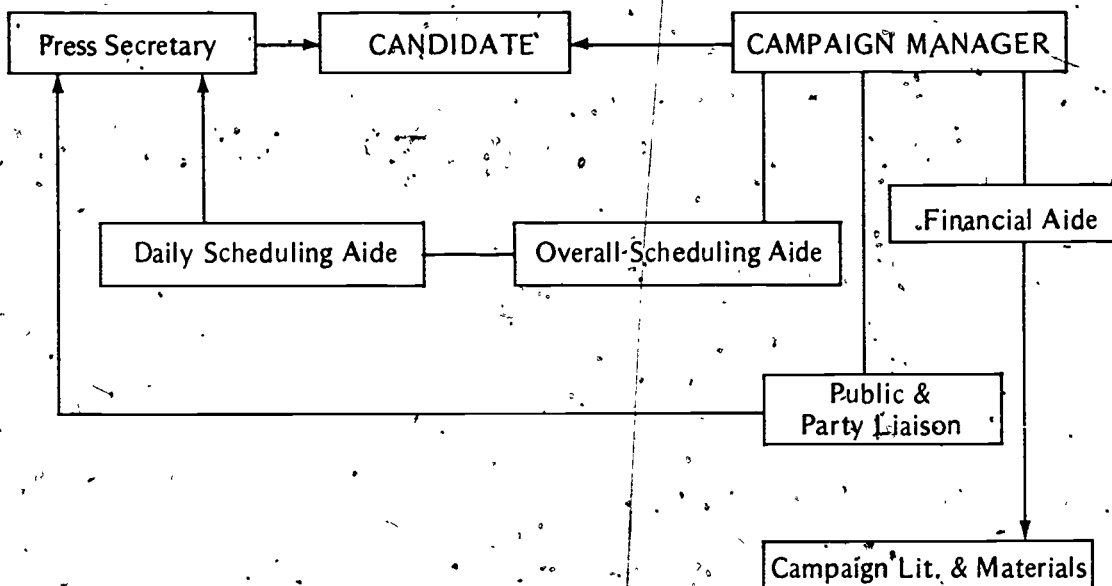

Refer to Appendix C, page 83 for Student Questionnaire on Campaign Staff; refer to Appendix D, page 91 for further campaign information.

BOARD OF ELECTIONS OBSERVATION

Election days offer numerous opportunities for students to observe and participate at the polling area for extended periods of time. Challengers are appointed by the county chairmen of the political parties or, in the case of local elections, by the municipal chairmen. Their powers include both the right to challenge any person claiming the privilege of voting, and the responsibility to remain during the tabulation and rejection of ballots in order to challenge questionable procedures (refer to *Voter Education Retrieval System*, page 58). The teacher should contact the appropriate individuals in advance to secure their approval for the position. The party is required to file applications for challengers no later than the second Tuesday preceding any election.

One-half hour prior to the opening of the polls the challenger, wearing proper identification, should present himself to the appropriate official as a member of the party to be represented. In addition, the challenger must be aware of how to contact party headquarters.

The physical arrangement of the polls and equipment should be checked; any irregularities or violations must be brought to the attention of the manager. Voting machines should be adjusted at zero and balloting containers emptied and secured. As the voter enters, the challenger should check the voter's qualifications by referring to the eligible voter list. At this point, the power may be exercised of challenging the eligibility of the individual to vote. After receiving the voting slip the voter must proceed directly to the booth without speaking to unauthorized personnel. Allow an appropriate time lapse for his or her vote (three minutes for a machine and five minutes for paper ballot). The voter must leave and not re-enter the polling area until after the polls close. The challenger should observe the tabulation procedures and contact the party headquarters to announce the results.

SUBTLE BIAS IN THE MEDIA

Introduction

How do people make decision on candidates and issues? How do the news media influence citizens to vote one way or another or to react to a given event in a desired manner?

These important questions must be addressed to enable people to discriminate between fact and fiction, not only with regard to the voting privilege, but actually in all facets of daily life. Polls show that people are generally uninformed as to the identity of the candidates in an election and the issues they espouse. Despite this, people do go to the polls and vote. By what guidelines do they pull the lever or mark the x next to the candidate's name? How do they decide to vote *yes* or *no* on an important bond issue, such as the establishment of gambling casinos in the state?

This section attempts to show the methods and techniques by which a newspaper can subtly influence its readers to vote for particular candidates or issues. It is important to differentiate *subtle bias* from *blatant bias*. Blatant bias is evident when a newspaper brazenly and openly displays its attitudes throughout the paper. Such bias is indicated when the paper provides numerous excellent articles on one candidate and little space, if any, for the opponent. The reader thereby knows immediately what position the paper takes. It must be noted that reference is to front page and general news coverage only, and not to editorial page comment where partisan support of this nature may be expected.

Subtle bias, as presented here, refers to the less-evident fact that, although both candidates receive equal coverage during the campaign, denoted by similar headline size and article space, the reader is being influenced by the newspaper in many unnoticed ways.

By applying the dimension of psychology to the reader's own reading habits and patterns, the newspaper media secure the effects of their subtle bias. The reader must become cognizant of this technique and influence.

In considering the entire subject of subtle bias in the media, a teacher needs only a copy of a newspaper. It must be stressed upon the students that the lesson is intended to develop not cynicism, but rather more criticism in analyzing candidates and issues.

Presented below are the major techniques used by newspapers in applying subtle bias, namely, prime location, spacing, pictures, headlines, and interviews. The material in this section is based on the expertise of news reporters who were willing to open the legendary "Pandora's box" in order to evaluate and scrutinize their decisions more carefully. The format of presentation is the teacher-student activity within a classroom structure.

Prime Location

The topic of "subtle bias" should be introduced with the emphasis that it is viewed from the perspective of the reading habits of the students.

The students are first asked what sections of the newspaper they normally read each day. (After choosing a few students, the rest of the class will volunteer to provide answers.) The list written on the blackboard will usually contain the following:

- | | |
|------------------|-------------------------------------|
| 1. sports | 7. classified |
| 2. front page | 8. social/fashion/women's |
| 3. pages 2 and 3 | 9. first page of each major section |
| 4. editorial | 10. financial |
| 5. comics | 11. last page |
| 6. obituary | |

As the list is being compiled, it may be necessary to stimulate answers by questions:

1. How many read "Dear Abby," "Ann Landers," etc.? (This depends on which newspaper is used.) In which section is this found? (Students will respond with either social, women's, or fashion section, depending on the newspaper.)
2. How many look for part-time jobs, or parts for a motorcycle or car? In which section are these found?
3. If most people read the first page of the newspaper, what other pages would also be read? Why? (Student response will normally be that they read pages 2 and 3, since front page stories are usually continued on these two pages.)

It should be made clear (to the students) that the list on the blackboard holds true for most adults and students throughout the country.

The list contains sections which a newspaper could use to "subtly influence" the reader. Notice the way the sports section could be used—open the paper and see that it could either start on the left or the right side (see picture 1, page 54a).

What happens if the sports section is started on the right side? They will notice portions of the page on the left side. Thus, the newspaper can place some headlines on the page to the left with the name of the candidate they favor. If done with sufficient frequency, that candidate's name is so impressed upon the reader that even if there is no familiarity with him or his position on issues, eventually his name will be recognized by the reader when he is in the voting booth. "The newspaper is not interested that the article is read, only that the name of the person is seen by the readers." This is technically called "setting up a frequency count."

Consider another example of subtle bias by location in the question, "what is a coffee klatch?" The basic answer is that a coffee klatch is a group of neighbors who get together for coffee and cake and talk to a candidate about his views on various issues.

Student response to the question, "in what section of the paper would an article of this type be located?" might be social, women's, or fashion. One student could lend his/her name for the following headline:

**THE BOWLEYS HOST COFFEE KLATCH FOR JOHN DARNEL,
ASSEMBLY CANDIDATE**

This type of headline in the social, women's, or fashion section accomplishes two things:

1. *Name frequency count*, as shown in the use of the sports page.
2. *Psychology of support*. By reading that people in their community are hosting events for a candidate, readers would assume that support is shown for the candidate at the grass roots level, rather than non-

support. The explanation for this influential technique is that many people tend to "sit on the fence" waiting to find out which candidate has the better chance of winning. "After all, nobody likes to pick a loser."

Another technique in the prime location method is the use of subtle bias on the classified or obituary pages. If a box is drawn on the blackboard to represent a page of a newspaper, and the words "Classified Ads" are written on the inside top of the drawing, it could then be shown that a newspaper has the option of covering the whole page with classified ads or only three-fourths of the page (see transparency master A in back cover fold for illustration). By using the remainder for news articles with headlines, featuring the name of the candidate it advocates, the paper once again is able to set up the frequency count.

Although a newspaper may emphasize that its coverage for candidates will be equal, there are two sections of the paper in which a candidate can be "buried." First, since most people usually read the articles on pages one, two, and three, they often tire, psychologically, and will skip over pages four and five. Therefore, if the articles of the opponent are placed on those pages, it is possible that the reader will never see them. The second prime area for "burying" articles on a candidate is the two pages following the editorial section of the newspaper. In most cases, the editorials cover two pages of concentrated "heavy" reading, so again people become psychologically tired and tend to pass over the next two pages.

Spacing

Spacing constitutes another area where the reading habits and patterns of people are exploited. The following class demonstration reveals this. A student comes to the front of the room and sits facing the class. When handed a newspaper, the student is asked to open it to page five. As he does so, his hands are grasped and held in place as shown in picture 2, page 54a. The class should notice where the student's hands are placed on the newspaper. (A person will always grasp the newspaper near the top.) Why are the hands placed on the paper in such a manner? The usual response is "that the newspaper will fold over." What part of the page is seen first when opening that paper? "The upper portion." A diagram is drawn on the blackboard of a newspaper opened to show the upper and outside corners as the prominent visual contact areas. (Refer to transparency master B.) If the name of the favored candidate is placed in these areas, he will gain more visible exposure than his opponent whose articles could be placed on the same pages with the probability of never being noticed if placed on "the lower inside fold." (as shown in transparency master C).

This again is subtle bias by strategic placing of articles on the same page. In doing this, a newspaper secures the desired impression without risking criticism of omission of opponents' activities.

Pictures

The strategic use of pictures constitutes another technique exploited by the newsprint media in effecting a subtle bias. This can be demonstrated by holding up a newspaper with a prominent picture on the front page as shown in picture 3, page 54a. When questioned as to what catches their attention, the students reply that it is the picture.

Presented below are four basic ways to demonstrate how a picture can influence the reader for support or non-support of the candidate.

Type

With two students at the front of the classroom, one stands behind the desk, facing the class, and the other between some of the students. (See picture 4, page 54a, for an illustration.) Accordingly, a photographer

covering an event takes a variety of shots, thereby giving the newspaper an assortment from which to choose. A poll taken of the class as to how many of them would be more positively inclined toward the picture of the candidate behind the rostrum or desk, and how many toward the candidate standing in the audience talking with the people, would show overwhelming support for the picture taken of the candidate in the audience. Thus, *the type of picture used can create either a positive or negative image of the candidate.*

Angle

Assume that two students face one another in the classroom, as shown in picture 5, page 54b. If all the seated students are moved from one side and placed together on the other side, then an empty seat background is created for one of the students at the front of the room.

If an angle shot were taken of the one student with the empty chairs as background, the students would realize that the background shot with this candidate displays "not many people." Would this indicate support or non-support for the candidate?—"non-support." (See picture 6, page 54b.) If, on the other hand, an angle shot were taken of the student with the background of the chairs filled, this would show "a lot of people." Would this indicate support or non-support for the candidate?—"support." (See picture 7, page 54B). Thus, by merely moving the camera to a different position in the room, it is possible to create the impression of support or non-support for the candidate. As emphasized previously, many people will vote for the candidate who they think has the support necessary to win.

It is an interesting fact that one of President Kennedy's campaign rules was that rooms used be too small. This was done for two reasons. (1) to avoid the problem of angle shots and (2) to create the impression of crowds and support.

As another demonstration of an angle shot, two students sit in the front of the class as if they were the candidates at a debate. The photographer (teacher) is positioned at an angle, as shown in picture 8, page 54b, for the students to see. A diagram of the picture which the photographer supposedly had taken can be drawn on the blackboard. (Refer to picture 8, page 54b, and transparency master D, for example.) The illusion is thus created that one of the candidates did not show up for the debate. The class, when asked whether they would react negatively or positively to the candidate who supposedly had not appeared, would usually have a negative response. If an article accompanied the picture, how many would read the article? Most people do not.

Students must also be made aware of the fact that a similar angle shot could make one candidate appear much larger or more imposing than the other (psychologically stronger), as shown in transparency master E.

Addition to Negative Headlines

This technique is a third use of pictures in subtly biasing the reader. A picture is drawn on the blackboard depicting police officers dragging several people from a local bar that bears a name the students would recognize. (See transparency master F.) Asked whether they would react negatively or positively to the picture, the response would be "negatively." The following headline is then placed on the board, as shown in transparency master G.

CANDIDATE FACES UNRULY CROWD

The class is then asked the following questions:

1. Does the headline convey a negative or positive feeling?—"negative."

2. Would it indicate support or non-support for the candidate?—"non-support."
3. What occurs when the picture is next to the headline?—"people tend to associate the picture with the headline." (See transparency master H.)

The same effect can be achieved if the picture is placed over the headline or to either the left or right sides. The placement of a picture in this way is referred to as *juxtaposition*.

When asked how many times they have seen a picture in the newspaper with no articles, the typical student response is "many times." Such pictures without articles are used as "fillers" because of spacing needs and a lack of articles.

Direct Eye Movement

If the newspaper is held up once again, the students are asked where their eyes tend to move on the page. The picture that is used will determine the direction in which the eyes will move.

Transparency master I, would elicit movement to the right and then downward as illustrated. This could be demonstrated to the class by means of a drawing on the blackboard (either to the right or left, then down).

If a picture is located on three-fourths, or more, of either side of the page, it is possible to create a blind spot on the remaining one-fourth. Thus, a page could be set up in such a way that the picture would direct the reader toward a headline on the candidate whom the newspaper supports. On the other hand, an article on the other candidate might never be seen because it is in the blind spot, as shown in transparency master I.

Headlines

The use of headlines constitute another major technique used by the newsprint media in effecting a subtle bias. It can be demonstrated in the following ways:

Articles

Ask the class approximately how many students could fit into the classroom. (Most classes can hold 30-40 students.) If there were sixty students in the class to hear a candidate, would the following be an accurate headline?

CANDIDATE SPEAKS BEFORE CROWDED AUDIENCE

Most students will think that the headline is misleading, but remind them that based on the conditions of the room, would it not be an accurate statement? Would it indicate support or non-support of the candidate?—"support."

In contrast, solicit a response from the students as to how many can be seated in the auditorium. Write a number on the blackboard which would be slightly less than half the seating capacity, e.g., for a seating capacity of 1,000 people, write the number 450. If 450 people were in the audience, would the following be an accurate headline?

CANDIDATE SPEAKS BEFORE SPARCELY FILLED AUDIENCE

The fact that there were 550 empty seats makes the headline true.

Another factor can be seen in the question of where the actual number of persons present can be found—"in the article itself." The following should then be written on the blackboard:

60

Sixty

Which of these are easier to register in the mind as to numerical quantity?—"60."

Since newspaper articles are written in pyramid form, with most of the information at the top, a diagram can be drawn on the blackboard illustrating this technique, as shown in transparency master J. Basic information included in the opening paragraph might indicate that candidate (name), running for (office), spoke before a group of students or adults at (place). No mention is made concerning the fact that there were only sixty people present.

Questions to be asked of the students would include:

1. How many read every word of an article? Most will admit to not doing so.
2. How many meander down the center of the article like this? (Draw inside of pyramid as shown in transparency master K.

This is a basic reading habit of most people, and creates blind spots down the sides of the article.

Therefore, it is important that the following items be taken into consideration:

1. the word "sixty"
2. the blind spots on the sides
3. the lower quarter of the page.
(See transparency master L.)

If placed in any of the above areas, it is almost guaranteed that nobody will ever know there were only sixty people in attendance. Conversely, the 450 could be "buried" in the same way so that people do not realize the large size of the group addressed by the candidate.

Advertisements

Of two advertisements to be selected from the newspaper, one should have much "filled space," with little white showing, the other should in contrast have a vast amount of white.

With both advertisements held up for the class, which one is more appealing and draws attention? Students usually respond to the one with a lot of white since "it is easier to see and more visually pleasant."

A headline is drawn on the blackboard twice, each the same size but with a different background, as indicated in transparency master M. The students are asked whether A or B is larger—"A appears larger because of the amount of white space, creating the illusion of size and visually appealing."

Interview Articles

How an interview is reported is significant in its subtle effect upon the reader. This is the last major technique to be illustrated.

With the help of the class, a student names seven major issues that confront the area and lists them on the board in this manner:

1. mass transportation
2. unemployment
3. education
4. welfare costs
5. environment
6. housing
7. state budget

The student is asked to imagine being interviewed as a candidate in regard to these issues, covering both the facts and plans on how he would deal with them. Would it be necessary to have ten, fifteen, thirty, sixty minutes or more to fully explain all views? Usually, the indication is that one hour is needed.

Can a reporter put a one-hour interview into the newspaper?—"no." What then must the reporter do?—"condense."

The students are then told that during the interview the candidate did well on numbers 1, 2, 4, 6 and poorly on 3, 5, 7 (using the list below as an example only).

1. mass transportation (good)
2. unemployment (good)
3. education (poor)
4. welfare costs (good)
5. environment (poor)
6. housing (good)
7. state budget (poor)

As written by the reporter, 75 percent of the article would cover the information on which the candidate did poorly and only 25 percent of the areas done well would be included, as shown in transparency master N. Remember, the reporter had to decide what was most important to include in the condensation. Would the article create a positive or negative image for the candidate?—"negative."

Conclusion

These five methods represent the *major* subtle ways in which a newspaper can influence its readers, if it were so inclined. Other techniques, sometimes used are misquotes or anonymous sources for information about the candidate. Some newspapers use these techniques on rare occasions; others may have a regular policy of influencing the public through methods rather than the actual strength of the candidate or issue.

In reference to issues, all the techniques discussed above can be readily used by the teacher for the demonstration of both sides of an issue. The issue is used as the headline rather than the candidates.

Suggested Activities

1. The students can make a frequency count on political advertisements for the major contests to establish whether or not the newspaper has been providing prime space and location to one candidate as compared to the other. This could also be done with articles on the candidates or major issues.
2. When a major issue emerges, the class can develop a questionnaire on the issue, and interview members in the community on a random sampling basis to discover their attitudes and knowledge of the issue. (See IPLE's booklet on *Community Research Techniques - How and Why?*.) At the conclusion of the newspaper coverage of the issue, the students again interview the same people to see if there has been a

shift in attitude and knowledge on the subject. The students should evaluate their findings to determine whether the newspaper had any impact on the people's attitudes.

3. The students can set up an issue analysis center to analyze critically whether an issue is media inspired, candidate inspired, or a legitimate issue of major impact. (Refer to Issue Analysis Center, page 15 of this manual, or IPLE's booklet on the Issue Analysis Center.)

NOTE. Media inspired does not necessarily have a negative implication. For example, if it were not for the *Washington Post* the Watergate story might still be deeply hidden.

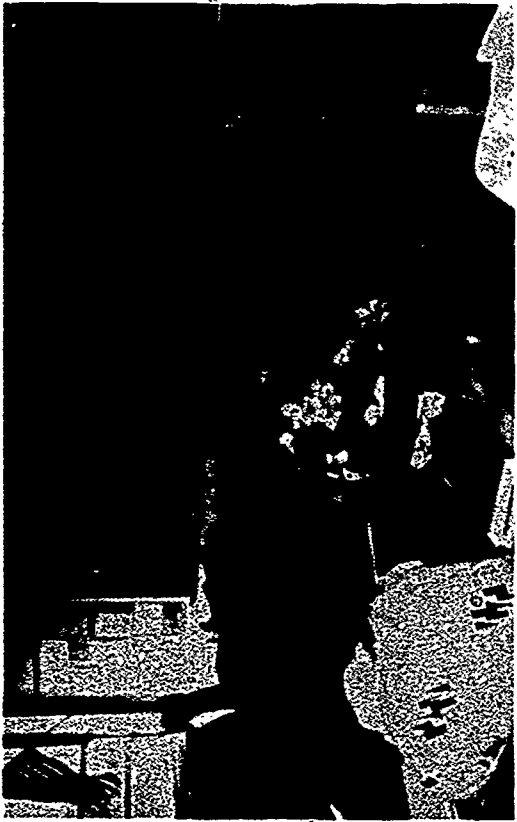

Placement of Hands

No. 2

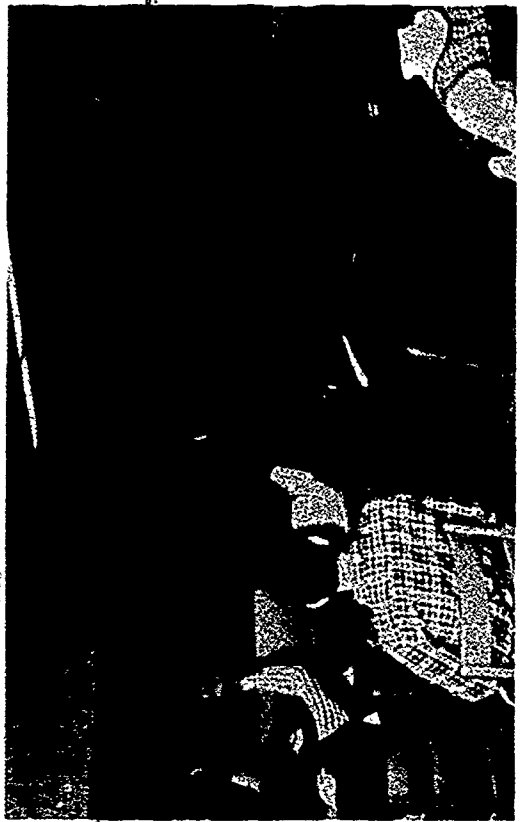

Type of Pictures

No. 4

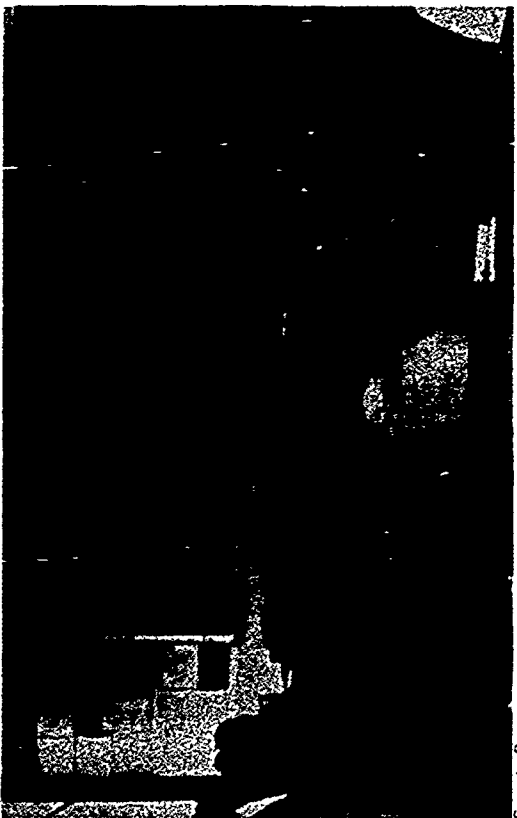

Sports Page

No. 1



Pictures

No. 3



Non-support Angle Shot

No. 6



Debate Shot

No. 8

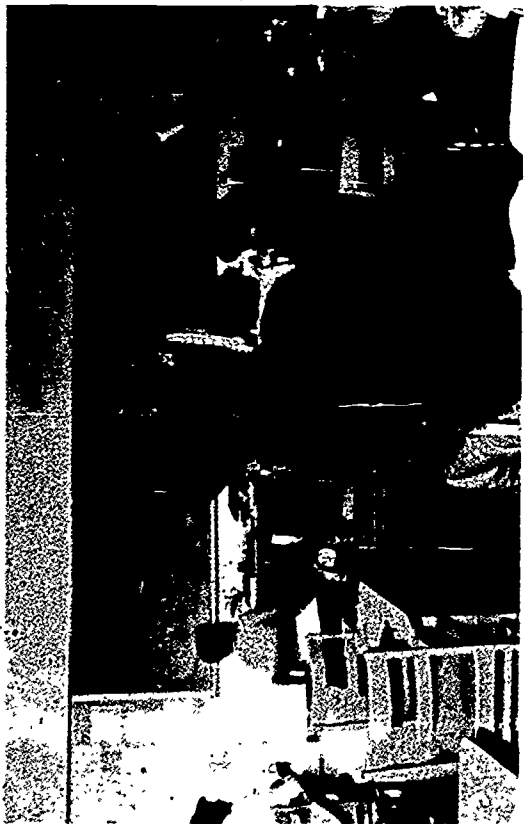

Angle Shot

No. 5



Support Angle Shot

No. 7

CHAPTER III

VOTER EDUCATION RETRIEVAL SYSTEM

STATUTES

Introduction

All individuals have a self-interest—the desire for fresh air, safety from physical violence, steady employment, the ability to secure adequate education and housing, etc.

In the American democratic political system, self-interests are promoted through the vote. Despite its inequities, the democratic system does offer all citizens the opportunity to participate in making decisions which determine the policies of their community and country. No other existing political systems offer this.

Through active participation in the political party committee system and through organized blocks of voters, the self-interests of the community are maintained.

Information concerning the act of voting—that first act to become a member of the decision-making community—is presented in a question-and-answer format from the New Jersey Title 19 revised election laws. In most instances, the precise language of the election code has been used with reference to the specific code sections. New Jersey students should use this section as a reference when providing information to the public during canvassing or registration activities. Students from states other than New Jersey should use the same questions as a basis for discovering the answers which apply to their particular state.

New Jersey's procedure for voter registration via the postal service is innovative and, if shown successful, may establish a model for other states. Students may wish to obtain copies of the election codes of other states for comparative purposes. Since some states, such as Indiana, have created bi-partisan study commissions to review election law, students will want to review the recommendations thus generated.

It should be noted that, because of a continually declining voter turnout, numerous federal and state proposals have arisen to facilitate voter registration and to update election laws. Such proposals have included:

1. an automatic registration plan whereby every adult over 18 years would be registered with or without their request.
2. a comprehensive door to door registration drive
3. a plan whereby registration would immediately precede voting
4. a post card registration.

Students will want to examine the pros and cons of each plan.

Particularly significant is the proposed legislation establishing a uniform federal voter registration system through the postal system. Congressional committees have held hearings on this proposal. While groups such as the League of Women Voters support this approach to voter registration, opposing groups express concern for the constitutional complexities related to federal vs. state jurisdiction, potential fraud and the cost of implementation. Consequently, no definitive action has occurred.

To keep abreast of federal and state legislative proposals in the field of election law, interested persons can research the monthly publication, *Federal-State Election Law Survey: An Analysis of State Legislation, Federal Legislation and Judicial Decisions* prepared for the Office of Federal Elections of the General Accounting Office by the American Law Division of the Congressional Research Service, Library of Congress.

The following questions and answers are based on New Jersey statutes. For other states, however, the questions will serve as guidelines for securing the relevant information.

Election Definition

What is an Election?

"Election" means the procedure whereby the electors of this state or any political subdivision thereof elect person to fill public office or pass on public questions. "General election" means the annual election to be held on the first Tuesday after the first Monday in November. "Primary election" means the procedure whereby the members of a political party in this state or any political subdivision thereof nominate candidates to be voted for at general elections, or elect persons to fill party offices, or delegates and alternates to national conventions.

R.S.¹ 19:1-1

Procedure for Filing for Office

How does a political candidate file for office?

Basically, the simple procedure of filing a petition of candidacy (see sample form in Appendix F) forty days prior to the primary election is all that is legally required to become a political candidate. Independent candidates must adhere to this filing procedure even though their names do not appear on the primary ballot. The forms for filing differ slightly according to the office sought, but in every instance, a specified number of signatures from registered voters must be obtained (e.g. 25 signatures for local offices in municipalities under 14,000 population; 100 signatures for county-wide office, assemblyman, and state senator; 1,000 signatures for governor and U.S. Senator; and independent candidates must submit signatures equal to 2 percent of the voters casting ballots in the last general election).

Petitions are filed with the municipal clerk, county clerk or secretary of state depending on the office sought (e.g. county-wide candidates and independents must file with the county clerk while candidates for state and federal positions file with the secretary of state). All candidates are reminded when filing for office that they "are required by law to comply with the provisions of the New Jersey Campaign Contributions and Expenditures Reporting Act."

R.S. 19:44A-1 to 44.

Committees, Boards and Challengers

What is the Membership and Organization of Municipal Committees?

The members of the municipal committees of political parties shall consist of the elected member of the county committee resident in the respective municipalities. The members of the municipal committee shall take office on the first Saturday following their election as members of the county

¹R.S. signifies revised statutes of Title 19 election laws with amendments, supplements, and acts concerning election procedures.

committee, on which day the terms of all members of such committees theretofore elected shall terminate. The annual meeting of each municipal committee shall be held on the first Monday following the primary election for the general election, at an hour and place to be designated in a notice to be given by the chairman of the outgoing municipal committee to each member-elect, at which annual meeting the members of each committee shall elect some suitable person as chairman to hold office for one year or until his successor is elected. The municipal committee shall have power to adopt a constitution and by-laws for its proper government. The chairman shall preside at all meetings of the committee, and shall perform all duties required of him by law and the constitution and by-laws of such committee.

R.S. 19:5-2

What is the Membership and Organization of County Committees?

The members of the county committees of political parties shall be elected annually at the primary for the general election in the manner provided in this Title for the selection of party candidates to be voted for at the general election by voters of a municipality. The county committee shall consist of one male and one female member from each unit of representation in the county. The male receiving the highest number of votes among the male candidates and the female receiving the highest number of votes among the female candidates shall be declared elected. Members of the county committee shall actually reside in the districts or units which they respectively represent. The county committee shall determine by its by-laws the units into which the county shall be divided for purpose of representation in the county committee.

R.S. 19:5-3

Who May Appoint Challengers?

The chairman of the county committee of any political party that has duly nominated any candidate for public office to be voted for at an election by all the voters within the county or any political division thereof greater than a single municipality, or where the election is within and for a single municipality, or any subdivision thereof, then the chairman of the municipal committee of the political party making such nomination within and for such single municipality, or subdivision thereof, may appoint two challengers for each election district in his county or municipality, as the case may be. The chairman of the county committee of each political party may also appoint two challengers to serve and exercise the powers of challengers, in each election district in the county at any primary election. A candidate who has filed a petition for an office to be voted for at the primary election, and a candidate for an office whose name may appear upon the ballot to be used in any election, may also act as a challenger as herein provided and may likewise appoint two (2) challengers for each district in which he is to be voted for; but only two (2) challengers shall be allowed for each election district to represent all the candidates nominated in and by the same original petition.

R.S. 19:17-1 19:7-2

When Must a Selected Challenger File an Application and/or Be Appointed?

The appointment of or application for challengers shall be filed with the county board not later than the second Tuesday preceding any election. No person shall be appointed a challenger under this title who is not a registered voter in the county in which the district is located in which such person is appointed to serve, and no appointed challenger shall serve in any district other than that to which appointed.

R.S. 19:7-3

What are the Authorized Powers of a Challenger?

Such challengers shall be the authorized challengers for their respective political parties and candidates or for the proponents or opponents of a public question. They shall have the power to challenge the right to vote therein of any person claiming such right and shall have power to ask all necessary questions to determine this right. They may be present while the votes cast at any election are being counted, hear and see the ballots counted and shall have the right and power to challenge the counting or rejecting of any ballot or any part of a ballot.

R.S. 19:7-4

What is the Composition of the District Boards?

The district boards in each election district shall consist of four members, who shall be appointed by the county board of the county in which such election district is located, in the manner hereinafter provided. In election districts in which the primary language of 10 percent or more of the registered voters is Spanish, the county board shall appoint two additional members who shall be of Hispanic origin and fluent in Spanish.

R.S. 19:6-1

What is the Responsibility of the Board of Elections Regarding Registration of all Eligible Voters?

Up to and including the twenty-ninth (29th) day preceding any election the commissioner, in counties having a superintendent of elections, and the members of the county board in all other counties, or a duly authorized clerk or clerks acting for him or it, as the case may be, shall receive the application for registration of all eligible voters who shall personally appear for registration during office hours at the office of the commissioner or the county board, as the case may be, or at such other place or places as may from time to time be designated by him or it for registration.

R.S. 19:31-6

Voter Registration: Qualifications/Procedures

What are the Eligibility Requirements for a Voter in the State of New Jersey?

He must be at least eighteen (18) years of age or over, a citizen of the United States and of the State of New Jersey, reside in the State of New Jersey for at least thirty (30) days and in the county for at least thirty (30) days immediately preceding the next general election.

R.S. 19:31-5

Is it Necessary to Register Prior to Every Election?

New Jersey's laws are designed so registration is permanent unless the voter has failed to vote during four (4) consecutive years; name appears on preemptory order list and has not re-applied; following a conviction of a crime and has received pardon or restoration of franchise; has changed name due to marriage, divorce or court order.

R.S. 19:31-13

19:31-5

19:32-18

19:31-17

Can Registration Be Accomplished Via The Postal Service?

Any person entitled to register to vote may register as a voter in the election district in which he resides at any time prior to the twenty-ninth (29th) day preceding any primary or general election.

by completing a registration card having his signature or mark witnessed by a person previously registered to vote in the county in which he resides and submitting the card to the commissioner of registration of the county wherein he resides. Any registration card shall be mailed to the commissioner to which it is addressed or delivered to such office. A registration card postmarked on the thirtieth (30th) day preceding any primary or general election shall be deemed timely.

When May Eligible Voters Registered During the Twenty-Eight Day Period Prior to Any Election Vote?

Applications for voter registration made in person or by mail may be accepted by all authorized persons during the twenty-eight day period prior to any election. Eligible voters who register during this period shall be advised that he/she will *not* be eligible to vote in the election immediately forthcoming, but will be eligible to vote in elections held thereafter.

R.S. 19:31-6

What are the Revised Laws Establishing Registration Not Only As Permanent, But Also Mobile?

In each county the commissioner of registration shall submit to the Secretary of State on or before February 15 of each year a plan providing for evening registration for the primary election and on or before July 1 plans providing for evening and out of office registration for the general election, which plans shall be subject to approval by the Secretary of State. Evening registration shall be made available in each municipality between the hours of 4 P.M. and 9 P.M. for at least three (3) working days immediately preceding the close of registration for the primary and general elections and for municipal elections. Such plan for out of office registration may include door-to-door registration, and shall include the schedule and route to be followed by the out of office registration units, as well as a description of the number and nature of units to be used, and such further pertinent information as the Secretary of State may rule or regulation requires. Out of office registration shall be made available pursuant to such plan in each municipality having a population in excess of 12,000 persons according to the most recent United States census. On or before the last school day on which a person may register to be entitled to vote in the ensuing primary election, the commissioner of registration in counties having a superintendent of elections, and the county board in all other counties, shall arrange for and conduct registration in each public and nonpublic high school in the county, of all students who are eligible to register to vote in the ensuing election. School officials shall cooperate with efforts to register students in such schools.

R.S. 19:31-2

What are the Provisions Regarding Change of Residence?

a. In all counties within this State, change of residence notices shall be made by a written request, signed by the registrant, forwarded to the commissioner by mail, and actually received by him, or by calling in person at the office of the commissioner or the municipal clerk. The commissioner shall provide change of residence notices in card form for the use of any registered voter moving to another address within the same election district or to another election district within the same county. Copies of these notices shall also be available at the office of the municipal clerk in each municipality. Each municipal clerk shall transmit daily to the commissioner all the filled out change of residence notices that he may have in his office at the time. These notices shall be printed upon cards, shall contain a blank form showing where the applicant last resided and the address and exact location to which he has moved and shall have a line for his signature. Upon receipt of such change of residence notice, the commissioner shall cause the signature to be compared with the permanent registration forms of the applicant and, if such signature appears to be by one and the same legal

voter, the commissioner shall cause the entry of the change of residence to be made on the permanent registration forms and the registrant shall thereupon be qualified to vote in the election district to which he shall have so moved. If the commissioner is not satisfied as to the signature on the request for a change of residence a notice shall be sent by mail, with postage prepared to the registrant at his new address, directing him to appear at a time to be fixed in the notice not less than ten days from the date thereof, at the office of the commissioner to answer such questions as may be deemed necessary to determine the applicant's place of residence and eligibility to vote. If such registrant fails to appear at the time and place as directed, or if the notice is returned as not delivered or if it is not returned as undelivered, the registration forms of the applicant shall be placed in the inactive file until such time as he establishes, to the satisfaction of the commissioner, the accuracy of the signature on such change of residence notice. provided, however, that such application for change of residence shall be filed with the commissioner or municipal clerk, as the case may be, on or before the twenty-ninth (29th) day preceding any election. All applications for change of residence postmarked on or before the thirtieth (30th) day preceding any election shall be deemed timely.

b. In any county any voter who shall move within the same county after the time above prescribed for filing an application for change of residence without having made application for a change of residence, shall be permitted to vote in the district from which he has moved, upon signing an affidavit which shall set forth (1) the date upon which he moved, (2) the address from which he moved, (3) the address to which he moved, and such affidavit shall constitute a transfer to the said new residence for any subsequent election. The county clerk shall furnish to the election board of each district, form affidavits for this purpose and the said district boards shall turn over all signed affidavits to the commissioner; provided, however, if the voter has moved from one residence to another within the same election district, at any time during the year he or she shall be permitted to vote in such election district only at the next election, subsequent to the date of such change of residence within the district, upon signing the affidavit herein set forth.

R.S. 19:31-11

Must Notification be Given to Applicants if Registration is Refused?

The Superintendent of Elections or the county board of elections shall notify a registrant of the reasons why his registration has been refused.

R.S. 19:31-6

What Provisions Govern the Printing and Distribution of Forms?

The Secretary of State will prepare and print the necessary forms and distribute them to the Commissioner of Registration in each county. Any person or organization requesting registration forms shall be given a reasonable quantity. Completed registration forms must be received by the Superintendent of Elections or the county board of elections. If the form is acceptable the registrant must receive a written notification that he/she is duly registered to vote. Registration forms submitted by mail are completed in duplicate. One form is to be pasted on to the original permanent registration form, the other to the duplicate permanent registration form.

R.S. 19:31-6

When Will the Commissioner Transmit To The Clerk A Complete List of Registered Voters?

On or before the fifteenth (15th) day preceding any primary election and on or before the fifteenth (15th) day preceding any general election the commissioner shall certify and transmit to the county clerk a complete list of all persons who are registered in each election district in each municipality in the county, together with a statement as to the number of persons registered in each district.

On the face of the list of registered voters the commissioner shall in figures state the total number of names of persons registered.

R.S. 19:31-18

In What Manner Shall Registration Cards Be Prepared?

The Secretary of State shall cause to be prepared registration cards of the size, weight and form described in this Title in both the English and Spanish language and shall provide such cards to each commissioner of registration of any county in which there is at least one election district in which bilingual sample ballots must be provided.

R.S. 19:49-4

Sample Ballots and Voting Procedures

What is the Procedure Governing Sample Ballots?

In counties having a superintendent of elections, and in other counties where the county board of elections shall elect to operate under the provisions of this Title, the commissioner of registration shall prepare and deposit in the post office on or before 12.00 o'clock noon, on the Wednesday preceding the general election day, a properly stamped envelope containing a copy of the sample ballot printed in English addressed to each registered voter in the county at the address shown on the registry, except that for districts in which the primary language of 10 percent or more of the registered voters is Spanish, a properly stamped envelope containing a copy of the bilingual sample ballot, addressed to each registered voter in the district of such board at the address shown on the register shall be prepared and deposited. The commissioner of registration shall return to the county clerk all ballots and envelopes not mailed or posted by him, with a sworn statement in writing signed by him that all the remainder of such ballots and envelopes have been mailed.

R.S. 19:14-25

What Are The Instructions For Marking The Voter Ballots?

- (1) The only kind of a mark to be made on this ballot in voting shall be a cross X, plus + or check √.
- (2) To mark a cross X, plus +, check √ or when writing a name on this ballot use only black ink or black-lead pencil.
- (3) To vote for any candidates whose names are printed in any column, mark a cross X, plus + or check √ in the square at the left of the names of such candidates not in excess of the number to be elected to the office.
- (4) To vote for any person whose name is not printed on this ballot, write or paste the name of such person under the proper title of office in the column designated Personal Choice and mark a cross X, plus + or check √ in the square to the left of the name so written or pasted.
- (5) To vote upon any public question printed on this ballot if in favor thereof, mark a cross X, plus + or check √ in the square at the left of the word "Yes," and if opposed thereto, mark a cross X, plus + or check √ in the square at the left of the word "No."
- (6) Do not mark this ballot in any other manner than above provided for or make no erasures. Should this ballot be wrongly marked, defaced, torn or any erasure made thereon or otherwise rendered unfit for use, return it and obtain another. In presidential years, the following instructions shall be printed upon the general election ballot:
- (7) To vote for all the electors of any party, mark a cross X, plus + or check √ in black ink or black pencil in the square at the left of the surnames of the candidates for President and Vice-President for whom you desire to vote.

Note. These instructions are for voting districts still using paper ballots. Voting machines are being utilized by an increasing number of districts. New methods such as punch card voting and computer counting are being developed.

What Individuals are Authorized in the Polling Area?

Members of District board; candidates standing for election; authorized challengers or agents of candidates; voters present for the purpose of voting; Superintendent of Elections or his deputies; members of County Board of Elections; and assigned police.

R.S. 19:32-21

R.S. 19:6-16

R.S. 19:13-8

R.S. 19:7-1

How Much Time is Allowed for Voting?

No voter shall remain in the voting machine booth longer than two minutes. After having cast his vote, voter must leave the polling room.

R.S. 19:52-3

What are the Laws Governing Loitering and Electioneering?

Loitering and electioneering are prohibited in or within one hundred feet of *outside* entrance of polling place.

R.S. 19:34-6

R.S. 19:34-15

What are the regulations governing absentee ballots?

Absentee ballots may be requested by those registered voters who cannot vote in person because:

- of expected absence from the state
- of illness or physical disability (including blindness and pregnancy)
- of observance of religious holiday
- of resident attendance at school, college or university
- of hours and nature of employment (for school board elections only).

Eligible registered voters desiring an absentee ballot should apply in person or by mail to the County Clerk for Primary and General Election; the Municipal Clerk for a Municipal Election, and the School District Clerk for a School Election, stating home address, address to which ballot should be sent, and the reason for the request. Sign with the same signature used at the polls. Ballot and instructions will be mailed to you.

An application for ballot must be received by mail no later than seven days preceding election. New emergency provisions: within the seven-day period, and until 3:00 p.m. the day before the election, you may vote absentee in person at the office of the County Clerk. If you are ill or incapacitated, you may send someone as your messenger with written authorization to obtain your ballot and return it to the County Clerk's office.

For School Elections, check with School District Clerk.

None receiving an absentee ballot shall be permitted to vote at their polling place. All absentee ballots must reach County Election Board by the close of Election Day.

ELECTORAL COLLEGE

Introduction

The United States, with the status of a democratic republic, is believed to have an open and democratic system of electing its President and Vice President. There are, however, members of both Houses of Congress as well as political analysts, observers, and professors who view this as a gross misrepresentation. In fact, the special commission on electoral reform of the American Bar Association concluded, after an extensive ten month study, that "The existing electoral system is archaic, undemocratic, complex, ambiguous, indirect, and dangerous. . . ."

Arthur Krock, Pulitzer Prize winning political journalist, wryly commented over twenty years ago, "The road to reform in the method of choosing the Presidents and Vice Presidents of the United States is littered with the wrecks of previous attempts."

This section presents the historical background of the electoral college and some of the more recent attempts of electoral reforms, along with the major reasons for their defeat at the committee level. It includes the history of the resolution and its analysis.

Many experts and analysts strongly feel that the present system of choosing our Chief Executive functions better than any of the proposed alternate systems. Their viewpoint is articulated through the Minority Report of the Senate Judiciary committee filed by Senators Ervin, Hruska, Eastland, Thurmond, McClelland, and Fong.

The information provided can be used both as a learning tool and a vehicle to stimulate debate on the topic through awareness of both pro and con arguments.

Historical Design of the Framers of the Constitution

In 1787 James Wilson of Pennsylvania spoke of the difficulty the Constitutional Convention had experienced in agreeing on a plan for choosing the President:

This Convention, Sir, was perplexed with no part of this plan so much as with the mode of choosing the President of the United States. . . . This subject has greatly divided the House, and will also divide people out of doors. It is in truth the most difficult of all on which we had to decide.

There was no shortage of ideas at the Convention on how to elect the President. Among the many plans proposed were direct popular election, election by the Congress, and election by the state legislatures. Direct popular election was opposed mainly because it was felt that the people, lacking knowledge of the candidates, could not make an intelligent choice. An election by Congress was rejected because it was believed that this would undermine the independence of the Executive. Similarly, the idea of election by state legislatures was defeated because of the fear that the President would be so indebted to the States that the exercise of Federal authority would be jeopardized.

Unable to agree upon a plan, the Convention appointed a "Committee of Eleven" to propose a compromise solution. The hybrid electoral college system was that compromise solution. The people would choose

electors in the first instance, either by direct popular election or through appointment by popularly elected state legislatures, but the electors they chose would, actually vote for President and Vice President. The electors, according to the original design, would vote individually for the candidates they believed best qualified for President and Vice President. As Alexander Hamilton wrote in Federalist No. 68, "a small number of persons selected by their fellow citizens from the general mass, will be most likely to possess the information and discernment requisite to such complicated investigations . . ."

History of the Latest Resolution

Senate Joint Resolution 1

The Subcommittee on Constitutional Amendments began the first of two sets of hearings on the election of the President on February 28, 1966. The subcommittee held eighteen days of hearings and heard testimony on all of the various plans for reform of the electoral system. More than fifty witnesses appeared before the subcommittee and the hearing record totaled nearly one thousand pages. (*Election of the President, hearings before the Subcommittee on Constitutional Amendments, 89th Cong., second sess. and 90th Cong., first sess.*)

Following the near electoral mishap in 1968, the subcommittee undertook a further study of electoral reform. In eleven days of hearings, the subcommittee heard forty-nine witnesses and compiled a second hearing record of more than one thousand pages. Once again, the subcommittee heard testimony on all the various plans for reform. (*Electing the President, Subcommittee on Constitutional Amendments, 91st Cong., first sess.*)

In September 1969, electoral reform became the pending order of business before the full Judiciary Committee. On February 3, 1970, the committee voted 13-4 to consider electoral reform by April 14 and to vote on the pending resolutions no later than April 24. Three additional days of hearings were held by the full Judiciary Committee on April 15, 16, and 17.

The full Judiciary Committee met in executive session on April 23. In the course of its deliberations, the committee rejected a number of substitute amendments, including the district plan (S.J. Res. 12), the proportional plan (S.J. Res. 2), the modified present system plan (S.J. Res. 191), and a number of other substantive amendments that would have altered the runoff provisions of Senate Joint Resolution 1. The committee then voted 11-6 to report the direct popular election plan embodied in the substitute version of Senate Joint Resolution 1.

Analysis of the Resolution

- Sec. 1. Abolishment of the present system of electing the President and Vice President. Replaced with election by direct popular vote. The people of every state and the District of Columbia would vote directly for President and Vice President. Candidates must consent to run jointly. This section would prevent a candidate for either office from being paired with more than one individual.
- Sec. 2. "Electors" would be changed from meaning members of the Electoral College to those recognized as qualified voters. Via the Voting Rights Act of 1970, uniform residency and voting requirements would be created and established on a nation wide basis.
- Sec. 3. In order to be elected President, a candidate must receive at least forty percent of the vote cast. If no individual receives at least forty percent of the vote, then there will be a run-off election held between the two pairs of candidates who received the highest number of votes cast.

Sec. 4. The times, places, and manner of holding such elections shall be prescribed in each state by the legislature thereof, but the Congress may alter at any time, by law, such regulations.

Sec. 5. The Congress may, by law, provide for the case of death, inability, or withdrawal of any candidate for President or Vice President before a President or Vice President have been elected, and for the case of the death of both the President-elect and the Vice President-elect.

Sec. 6. The Congress shall have the power to enforce this article by appropriate legislation.

Sec. 7. This article shall take effect one year after the 15th day of April following ratification.

Defects of the Present System

The appearance of political party candidates as early as 1800 meant, in effect, that Hamilton's concept of a "select assembly" of independent electors already had lost its purpose only a decade after its embodiment in the Constitution. More than one hundred twenty-five years later, however, the elector still retains his constitutionally guaranteed independence. In January, 1969, Congress confirmed this 18th century prerogative by accepting the vote of a popularly chosen Republican elector from North Carolina who had cast his vote in the Electoral College for George Wallace, the American Independent Party candidate.

The prospect of unknown electors auctioning off the Presidency to the highest bidder, nevertheless, is all too real. That is the lesson of 1968, when the present electoral system brought us to the brink of Constitutional crisis. A shift from Nixon to Humphrey of only forty-two thousand popular votes in three states would have denied Nixon an electoral majority and given Wallace, with his forty-six electoral votes, the balance of power!

What Is Wrong With The System?

- It can elect a President who has fewer votes than his opponents and thus is not the first choice of the voters.
- It awards all of the state's electoral votes to the winner of the state popular vote, whether his margin is one vote or one million votes.
- It cancels out all the popular votes cast for the losing candidate in a state and casts these votes for the winner.
- It assigns to each state a minimum of three electoral votes regardless of population and voter turnout.
- It provides for a patently undemocratic method of choosing the President in the event that no candidate receives an electoral majority.
- It adheres to the Unit Rule which *is not even a constitutional provision*. This "winner-take-all" formula is a state practice. In effect, millions of voters are disenfranchised if they vote for the losing candidate, because the full electoral power of their state, *the electoral vote, is awarded to the candidate they opposed.*
- A candidate could win a *majority* of the electoral vote by capturing statewide pluralities in only eleven largest states and the District of Columbia. (This means, in effect, that in 1968, 25 percent of the popular vote could have elected the President!)
- The present electoral system cannot guarantee that the candidate with the majority of the popular vote will be elected the President.
- In 1824, 1876, and again in 1888, this system produced Presidents that were not the popular choices of the voters!
- Good fortune, not design, has produced Presidents who were the popular choices of the people.

The Tests of A Modern Electoral System

1. It must guarantee that the candidate with the most votes is elected President.
2. It must count every vote equally.
3. It must provide the people themselves with the right to make the choice directly.

Note. This list is part of the findings of the American Bar Association's blue ribbon committee on electoral reform, which concluded a ten-month study.

Minority Report: Senate Committee

One of the important pieces of business to come before the Senate in recent years is consideration of the system of presidential election. Among the proposals for reform are those which recommend moderate change, those which recommend extensive alteration, and those which demand complete abolition. Many people believe that the Judiciary Committee, in recommending the destruction of the electoral-vote system in favor of direct election, has embraced a scheme that will adversely affect the entire constitutional and political structure of the United States. There are many others who realize that the present system has its defects; however, they also believe that remedies are available short of its wholesale destruction.

In his statement in opposition to direct election, former Attorney General Nicholas De B. Katzenbach commented

"I strongly feel that on a matter so basic to the confidence and structure of the country, we ought not to abandon the familiar and workable for the new and untried without the clearest demonstration of need. In my judgment, no such demonstration has been made. We should not substitute untried democratic dogma for proven democratic experience"

Probable Consequences of Direct Election

- The two-party system would be destroyed thereby encouraging the formation of a host of splinter parties.
- The Federal system would be undermined by removing the states as states from the electoral process.
- Indispensable institutional support for the separation of powers would be removed.
- Public opinion would be radicalized, endangering the rights of all minorities by removing incentives to compromise.
- An irresistible temptation for electoral fraud would be created.
- Tedious electoral recounts and challenges might be a usual proceeding.
- National direction and control of every aspect of the electoral process might be necessitated.
- The great possibility of a run-off election would induce many more candidates to run, and to withdraw only *after* the first election.

Recent Reforms Defeated in Committee

District Plan

The district plan would retain the electoral vote, with electors chosen from single-member districts within each state and two electors running at-large statewide.

Proportional Plan

The proportional plan would retain the electoral vote, but replace the unit rule with a proportional division of a state's electoral vote on the basis of the popular vote in that state.

Modified Present System

The modified present system would write into the Constitution for the first time the major defect of the present system—the unit rule.

The question of election form has been long debated in the U.S. Senate. It would be of value to secure students opinions on whether reform is needed, and what direction it should take. Their points of view can be expressed through formal debates, round table discussions, or written reports.

PARTY STRUCTURE

Introduction

Politics in the United States, as in any country, is primarily a process of competition for diverse interests. Various groups and organizations in the United States, in one way or another, have tremendous influence on public opinion and policy. Political parties, too, have a great impact on public decisions. Their main purpose, however, is to win elections and to strengthen the democratic system.

Most Americans believe that problems should, and will, be solved at a national or state level, rather than in the community. This is substantiated by the fact that the greatest number of citizens vote in the presidential election, while the number of voters steadily decreases with proximity of the election to the community. What most Americans do not understand is the party organization and the very meaningful political party involvement that does exist in their own community. Even if the major concern is the election of a president of the United States who represents the political philosophy and social self-interest, the existence of a strong community base makes the coordination of a local, county, and even state campaign a much easier and more orderly process. The following information is provided to give the student a basic understanding of party organization, the process by which political decisions are made, and an awareness of the political opportunities which exist in the community.

Organization

A party's National Committee normally consists of a small staff, which in an election year expands to a staff of approximately three hundred. National party committees, made up of representatives of the state parties, choose candidates for President and Vice President and approve a party platform. Each state has two national committee persons, a man and a woman; however, the method of selection varies from state to state.

Most states have a state committee; county, city, or town committees; and district, ward, or precinct committees. The rules and regulations concerning organization, duties, and operation of parties in each state are determined by state legislatures.

Local committeemen are chosen either by local party meetings or in primary elections. They in turn automatically belong to the county committee or help to elect the representatives to that committee. In most states the county, town, or city committees elect representatives to the state committee. In some states, however, the committee is comprised of representatives from congressional districts, state senatorial districts, or state legislative district committees.

Many Americans believe that the national party controls political affairs straight down the line starting with the National Committee and going down to the Precinct; however, the exact opposite is true. The party organization is shown in diagram form.

Party Organization

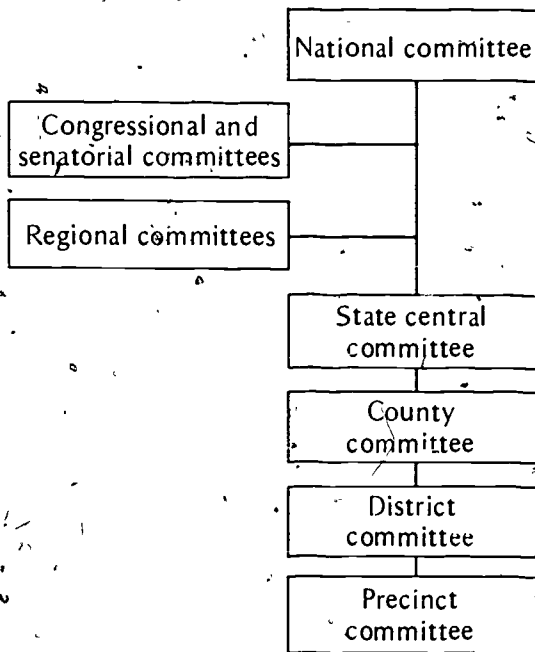

"A Committeewoman Speaks Out"¹

by Dathene Leve

I have been interested in the general term "politics" since I was old enough to spell the word. I followed elections and argued over candidates and issues long before I was old enough to vote. So I suppose it was natural for me to become involved at the first opportunity.

That opportunity came during the Presidential election year of 1968. One of the candidates was scheduled to make an appearance in my community and I wanted to help in the campaign. So I "let my fingers do the walking." I found the county headquarters number in the phone book, called and asked to help. They put me in touch with the municipal chairman, and presto! I was "in politics." My election district had a committeewoman at that time, so I in effect became her apprentice. I attended all county committee meetings (which, with the exception of re-organization meetings, are *open* to the public), helped hand out literature, addressed envelopes, made phone calls, knocked on doors, and sat at the polls on election day. When the time came and she felt she could no longer continue on the committee, due to personal and business commitments, I filed a petition, ran in the primary, and presto! I was a "politician." And it's a title for which I have worked very hard and of which I am extremely proud. Contrary to popular belief in these post-Watergate days, the term "politician" is not synonymous with "crook." There have been other scandals in government, possibly some that have remained hidden, with far worse effects on the American people. There will doubtless be more in the future. But the good that has been done by dedicated and responsible men and women so far outweighs the bad that it is almost ridiculous to compare them. And a footnote if I may - the key figures in the Watergate scandal were *not* politicians. With one exception, *not one* of them had ever been elected to public office.

Another seemingly popular misconception is that few politicians have high ideals - most seem to do nothing but deal and compromise. I defy anyone to find any area of life, whether school, job, marriage, or whatever, wherein it is not necessary to compromise or make deals. The vast majority of politicians are idealists, for the very basic nature of our government is to do good, to make a better life for all. One has to be a bit of an idealist to want to become involved at all. But there also is the need to be practical - without compromise *no one's* ideals would ever become reality. Without give and take, nothing at all can happen. No two people think exactly the same, no one is ever all right or all wrong. So a compromise simply takes some from me, some from you, puts it all together in a workable form that, in the end, benefits us both. Through politics, that end result has made it possible for us to live in a free country with an ever-increasing standard of living comparable to no other nation on earth.

Our system of government is based on a two-party system that, while having some drawbacks, still works better than anything else. Within a party, as with any group of people working for a generally common cause, there must be organization, rules, standards of operation, leaders and followers.

That there are those who misuse whatever power or authority they have cannot be denied. But these people would likely make use of any field of endeavor for their own selfish needs.

As for glamour and financial gain, I cannot, quite naturally, speak for all committees everywhere, but I

¹This article was prepared for this manual by Dathene Leve, Committeewoman, Willingboro, New Jersey.

believe most committee people are far removed from either. I am a committeewoman, 2nd Vice-chairman of the municipal committee, and have a low license number, all of which, combined with twenty cents, would buy me a cup of coffee. I am on a first name basis with local and county selected officials from whom I have received nothing more than an occasional free ticket to some affair or other. Some of the people I have met through politics I dislike intensely, most I think very highly of, and a few I consider to be good friends. The glamour usually consists of nothing more than the excitement on election day, the exhilaration of victory after a long, hard campaign, and occasionally being at the same place at the same time as a reporter or T.V. camera. There is nothing more exciting than a victory celebration—nothing more heart breaking than a close defeat, and nothing more satisfying than knowing whatever the outcome, you've done your best.

I realize everyone does not share my enthusiasm for politics and government, but the *only* way to insure good government is to have as many good people as possible involved. When the good ones don't care, the field is left wide open for the corrupt, greedy and power-hungry. It is very true that you get the government you deserve. If you feel things aren't right or could be improved—get involved—get to know your party's goals, achievements and people; make it your business in any way you can. I don't think you'll regret it.

State Organization

The following section describes the way in which party structure works and the general rules and regulations concerning party organization:

At the top of both the State Democratic and Republican parties are the State chairman, vice-chairman, and executive director. All are elected by representatives of the county organizations; the executive director is the full-time party official and receives a regular yearly salary.

It is the procedure for both the Democratic and Republican parties that if the State chairman is a man, then the State vice-chairman will be a woman and vice-versa. The executive director, however, may be a man or woman.

Members of the state committees of political parties are chosen (one male and one female for each county) for terms of four years at the Gubernatorial primaries and take office one week after being elected. Vacancies are filled for the unexpired term by the respective county committees. (It should be noted that the concept of "one-man one-vote" representation used in legislatures does not follow in the party structure.)

The county leadership is similar to the state structure for both parties. The county chairman, vice-chairman, and executive director are all elected by representatives from local municipal organizations.

The male-female relationship between county chairmen and vice-chairmen is again the rule as with state policy. The executive director remains the full-time staff person with a yearly salary.

The local municipal chairman is elected by the local committeeman and committeewoman, the legally designated representatives of the local party structure. Thus, a quick glance at the relationship between state, county, and local parties will indicate several well organized structures which would control the election of local, county, and state leadership. And they do.

This is why individuals from "strong" counties seem to have a majority of leadership positions, while some "weak" counties have no representation at all. There is one significant characteristic of any powerful county or state political machine. Its basic support is found in the home community of its major political leaders, and while this may or may not always be 100 percent true, it is applicable in a majority of cases. In politics, most things don't just happen—they occur for very logical reasons. These reasons will be examined in the following review of the basic and often-kept secret structure of the county committee system.

County Committee System

Coinciding with primary elections for candidates who will receive party endorsements in the following general elections is the election of county committeemen and committeewomen.

This is potentially one of the most important positions in the political structure. Every municipality is broken down into districts. In each election district, regardless of the number of party voters therein, the registered members of a political party (Democratic, Republican) elect two county committee people to represent them: one committeeman and one committeewoman. They serve for one-year terms.

Any voter is eligible to run for a committee post but must file petitions supported by the signatures of ten registered party voters forty days before the primary. All committeemembers are unsalaried.

(Municipal committees are made up of the county committeemen and women within municipal boundaries. Municipal chairmen act as liaisons with the county chairman.)

The committee people have the following responsibilities and privileges:

1. to promote party interests:
 - a. acquaint each voter with candidates and issues
 - b. assure that voters get to the polls.
 - c. canvass district to be aware of new arrivals, and learn voting tendencies of each voter, if possible.
 - d. be available to each person as their *elected representative* to the party.
 - e. act as liaison between voters and candidates.
2. to increase the membership of actual party workers and club members,
3. to assist in voter registration,
4. to check voting lists,
5. to serve as poll challengers during elections,
6. to elect the local municipal chairman,
7. to elect all other municipal party officers,
8. to decide municipal party policy,
9. to determine how municipal party funds are spent,
10. to serve on the country party committee,
11. to appoint a District Election Board Worker.
Each committee-person recommends an individual to serve for one year on the County Election Board. This person receives forty dollars for the election day which begins at 7 a.m., and lasts until results are turned in and tabulated.
12. County Committee may apply for low license plates for themselves and/or other party workers through a state senator. Cost is ten dollars.

In terms of responsible political activity, sincere, civic-minded committeemen and committeewomen could help elect municipal party leaders who share these ideals and thus provide a base of support for similarly minded candidates in their own communities. Unfortunately, however, rather than a vehicle for responsible action, the committee system has long been the method of voter manipulation often used by political demagogues for private self-interests and gain.

County Committee Machine

Have you ever wondered how a political giant has successfully survived so long in the political system? The key to much of his (or her) success may be found in the county committee systems.

All activities of the party within the county are directed nominally by the county committees, the most powerful units of the party system. The committees choose the candidates who will run in primary elections (endorsements, although not formally permitted, are tantamount to election in most cases), recommend appointments, and implement party policy. Patronage, other than the Election Board, is not

within the realm of the committee-person. It starts with municipal government elected officials. The party affiliation of the majority of those serving in the local government usually determines the direction of appointments to government jobs.

Within the county committee, the *key* figure is the county chairman, who plays the leading role in:

1. securing candidates for elective offices;
2. organizing registration drives;
3. preparing for elections;
4. organizing social and fund-raising functions.

He also provides a linkage between the county committee and the formal structure of county government. The chairman's base of power is grounded in:

1. his influence as an appointed or elected official;
2. his position as a powerbroker;
3. his tenure as chairman. These factors help to make the county chairman one of the most powerful figures in the party organization.

It is clear that most Americans do not vote in committee elections. The poll of student leaders suggests the hypothesis that most Americans are ignorant of the committee structure.

This means that an individual who *does* understand it has a clear political advantage over those who do not. A scrutiny of the lasting political bosses reveals that many committeemen or committeewomen who began their careers concurrently with their emergence as a municipal or county leaders, now have either advanced politically or have remained, by choice, county committee persons.

Many committee persons who remain loyal to the party leadership have retained their seats for over twenty to thirty years. This indicates that rather than evolving into a vehicle for responsible social and political action, the committee system has become a method of repaying and insuring party loyalty.

In fact it is quite natural to expect the party leadership to sit down and decide, in advance of a primary contest, who will make a "good" (i.e. loyal) committeeman or woman. This individual then has his name placed on the ballot 85 percent of the time unopposed - and the LOYAL PARTY VOTERS in that district are urged to vote in the primary.

Thus, while in theory the committeemen and women elect the municipal chairman, in practice it is quite the opposite since the municipal chairman decides who the committee persons will be, gets them elected, and in turn gets himself (or his designate) re-elected. In such a manner, party leadership is perpetuated.

There are two methods by which party leadership insures committee control. The first occurs when a party controls the municipal elected officials. This provides the opportunity for various appointments (known as the spoils system) whereby elected and prospective county committeemen and women are given county or local jobs. Their employers are, in fact, the political bosses who secured these jobs for them and who can have them fired on order. Thus, their loyalty to the party incumbent leadership is further guaranteed.

A second method of introducing committeemen and women to their voting (and prospective voting) party constituency is by appointing them to chair the local Red Cross, March of Dimes, or some other philanthropic drive.

Usually a full slate of contested races for committee seats occur when either a new leadership emerges in the party or when incumbent party leadership is indicted for graft or corruption:

The pattern of "machine politics" as described above, while operating in many big cities, is far from being true in small towns and suburbs. Otherwise, it would not be as difficult as it is to get committee people. Much more work is involved than any financial or political power gain would justify. Good committee people are judged by how hard they work—a different connotation to the word loyalty.

The examination of the described methods above is by no means meant either to condone or to condemn them, but to simply expose the new voter to the way politics generally works.

Just as the committee system can, and sometimes has, been used for manipulation of political powers, it also represents the major vehicle for party reform and responsible political action. All young people who wish to become involved in politics should be urged to choose the party of their choice and become involved as an organized group in the committee system.

STATE PARTY STRUCTURE
(SAME FOR DEMOCRATIC AND REPUBLICAN PARTIES)

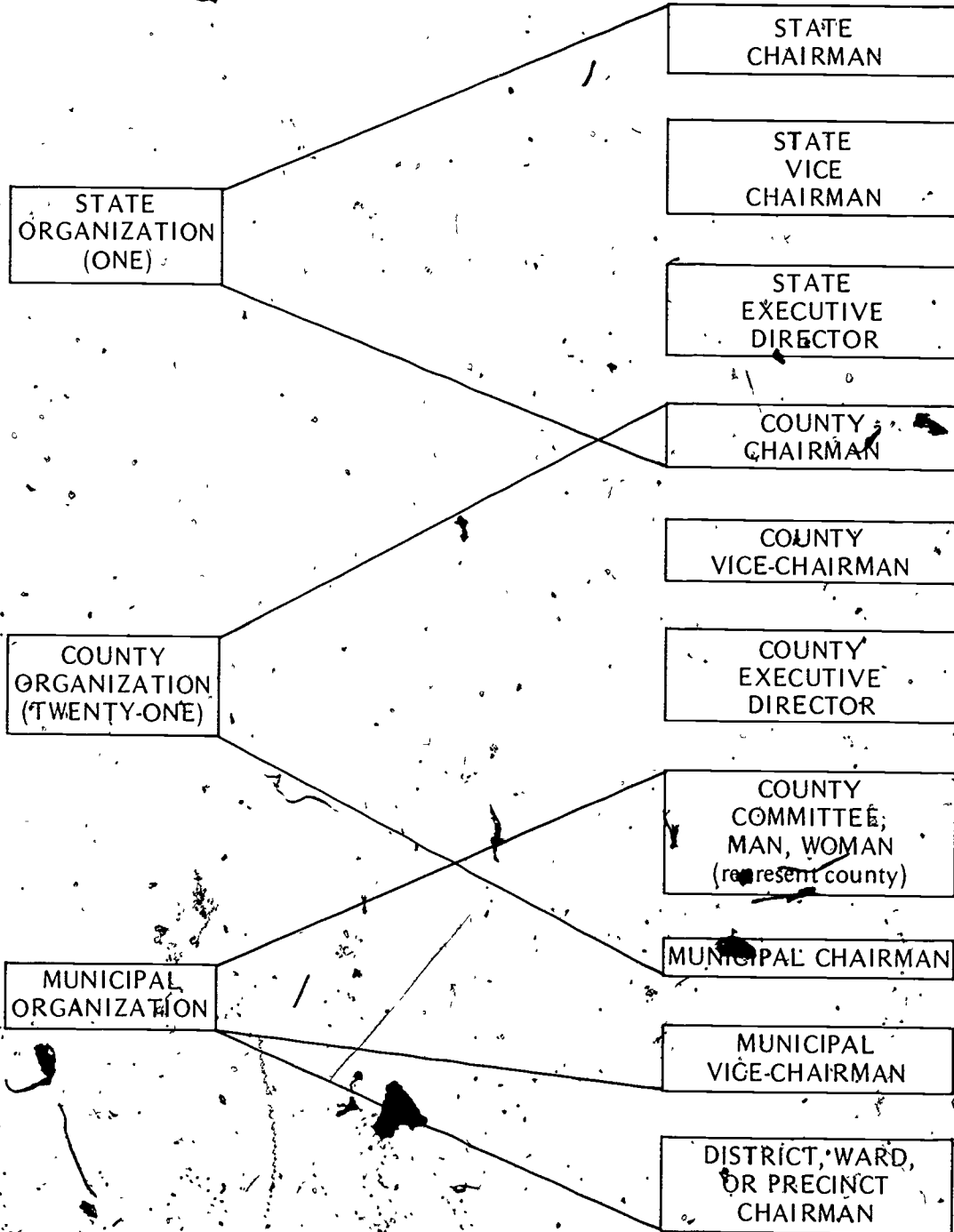

APPENDICES

APPENDIX A

PRESS RELEASE

This is a sample press release adapted from an actual article featuring the Institute's voter education program. Compare and note the techniques utilized in developing the format and content, especially if release is longer than one double spaced page.

FOR IMMEDIATE RELEASE

For further information contact Scott Callan, Publicity Chairman, Holy Cross High School at (609) 416-5403.

(caption and photo attached)

The Institute for Political and Legal Education of Holy Cross High School is sponsoring a special mock election in order to provide the students with voter registration experience. By using voting machines and by listening to debates and discussions by actual candidates and present office holders, the students learn the details of the election process.

The Institute experimental class is one of ten federally-funded classes in New Jersey, acting as a model for both the state and nation. Professional training is provided in politics, government, and community services through work in the classroom as well as in the community.

(MORE)

ADD 1—Simulation Election

The teacher-coordinator, Mr. John Goudy, stated that the students divided themselves into two political parties, after they received training by county party leaders. The students are now screening candidates to run on their party tickets.

In order to vote in this election, students will have to go through simulated voter registration using copies of the actual form. Student Election Board Chairman, Richard Felice, is running the registration.

Assembly programs will be aired in order to provide the student body an opportunity to hear the views of student candidates running for State senator, assemblyman, and mayor.

The members of the class will be assigned to each candidate as campaign managers. This will involve speech writing, developing campaign materials, and publicity for candidates.

The students elected will serve one full day in office assuming the roles of their counterparts. Voting machines will be used in the election. [30]

APPENDIX B

POLITICAL PARTY PLATFORM

During the simulation election, the student parties will be required to formulate individual platforms. Contained below is a sample platform to be used as a representative model.

PREAMBLE—"The people are cynical about the idea that a rosy future is just around the corner . . . They feel that the government is run for the privileged few rather than for the many—and they are right . . . We want to speak for, and with, the citizens of our country . . ."

COMMUNITY DEVELOPMENT—"We strongly oppose the use of housing or community development programs to impose arbitrary housing patterns on unwilling communities. Neither do we favor dispersing large numbers of people away from their homes and neighborhoods against their will."

LABOR—"We will continue to search for realistic and fair solutions to emergency labor disputes, guided by two basic principles: first, that the health and safety of the people should always be paramount; second, that collective bargaining should be kept as free as possible from government interference."

WOMEN—"We pledge a priority effort to ratify the Equal Rights Amendment, to encourage the availability of maternity benefits to all working women, and to permit working families to deduct from gross income, as a business expense, all housekeeping and child care costs. And we pledge the appointment of women to positions of top responsibility, including the Cabinet and the Supreme Court. And we finally pledge that the Federal government will fund comprehensive, developmental child care programs that will be family-centered, locally controlled, and universally available."

LAW ENFORCEMENT—"We pledge to intensify efforts to prevent criminal access to all weapons, including special emphasis on cheap, readily obtainable handguns, and at the same time, to safeguard the right of responsible citizens to collect, own and use firearms for legitimate purposes, including hunting, target shooting, and self-defense."

DEFENSE—"We will insist on the firm control of specific costs and projects . . . The military budget can be reduced substantially with no weakening of national security."

AMNESTY—"We state our firm intention to declare an amnesty, on an appropriate basis, when the fighting has ceased and our troops and prisoners of war have returned."

HOUSING—"We pledge to overhaul completely the Federal Housing Administration to make it a consumer-oriented agency, and to use the full faith and credit of the Treasury to provide direct, low-interest loans to finance the construction and purchase of decent housing."

LABOR-MANAGEMENT—"We oppose the Administration's effort to impose arbitration in transportation disputes."

APPENDIX C

STUDENT QUESTIONNAIRE ON CAMPAIGN STAFF

Campaign Manager

Why do candidates have campaign managers?

What is the basis for selecting a campaign manager?

What are his duties and responsibilities?

How much final decision-making power should be delegated to the campaign manager?

Is ONE campaign manager enough?

Article titled "How to Lose an Election" by Raymond
H. Bateman from The New York Times Magazine removed
to conform with copyright laws.

IMPORTANT: INSTRUCTIONS
Please read carefully before completing form

- Items 1, 2, 3, 4, 6 & 7 must be completed in full by the applicant. Complete item 5 only if you were previously registered.
 - Item 8 must be signed by a registered voter of the State of New Jersey.
 - NOTE: If applicant is unable to sign his or her name, a mark must be affixed to the line designated "Signature or Mark" on line 7, then item 9 must be completed by the person who filled out the card.
- 3. COMPLETE BOTH FORMS.**

DETACH INSTRUCTION PANEL ALONG DOTTED LINE BEFORE MAILING FORM

VOTER REGISTRATION FORM
PLEASE PRINT OR TYPE

1	Name LAST FIRST MIDDLE	Birth Date MONTH DAY YEAR
3	Residence STREET ADDRESS APT NO	MUNICIPALITY
4	I have resided at the above address since MONTH DAY YEAR	COUNTY ZIP
5	Where did you last register to vote? STREET ADDRESS CITY STATE ZIP	COUNTY MUNICIPALITY
6	I am <input type="checkbox"/> native born, <input type="checkbox"/> naturalized (Strike one) citizen I was naturalized MONTH DAY YEAR	MUNICIPALITY STATE
7	By the time of the next general election, I will be at least 18 years of age, I will be a citizen of the United States, and I will have resided in this State at least 30 days and in the county of _____ at least 30 days. To the best of my knowledge and belief, all the foregoing statements made by me are true and correct. I understand that any false or fraudulent registration or attempted registration may subject me to a fine of up to \$1,000.00 or imprisonment of up to 6 months or both pursuant to R.S. 19:34-1.	
8	SIGNATURE OR MARK	DATE
9	I, being a registered voter in _____ county in the State of New Jersey, witnessed the above signature or mark.	
8	SIGNATURE	DATE
9	NAME (Please Print)	COUNTY ZIP
9	STREET ADDRESS	MUNICIPALITY
9	If the voter is unable to sign his or her name, the voter shall make his or her mark, which mark shall be witnessed. The signature, name and residence of the registered voter in the State of New Jersey who filled out this form are:	
9	SIGNATURE	DATE
9	NAME (Please Print)	COUNTY ZIP
9	STREET ADDRESS	MUNICIPALITY

APPENDIX E

THIS FLAP IS GUMMED
JUST FOLD FORM IN HALF, MOISTEN THE GUMMED AREA AND SEAL

VOTER REGISTRATION FORM
PLEASE PRINT OR TYPE

1	Name LAST FIRST MIDDLE	Birth Date MONTH DAY YEAR
3	Residence STREET ADDRESS APT NO	MUNICIPALITY
4	I have resided at the above address since MONTH DAY YEAR	COUNTY ZIP
5	Where did you last register to vote? STREET ADDRESS CITY STATE ZIP	COUNTY MUNICIPALITY
6	I am <input type="checkbox"/> native born, <input type="checkbox"/> naturalized (Strike one) citizen I was naturalized MONTH DAY YEAR	MUNICIPALITY STATE
7	By the time of the next general election, I will be at least 18 years of age, I will be a citizen of the United States, and I will have resided in this State at least 30 days and in the county of _____ at least 30 days. To the best of my knowledge and belief, all the foregoing statements made by me are true and correct. I understand that any false or fraudulent registration or attempted registration may subject me to a fine of up to \$1,000.00 or imprisonment of up to 5 years, or both pursuant to R.S. 19:34-1.	
8	SIGNATURE OR MARK	DATE
9	I, being a registered voter in _____ county in the State of New Jersey, witnessed the above signature or mark.	
8	SIGNATURE	DATE
9	NAME (Please Print)	COUNTY ZIP
9	STREET ADDRESS	MUNICIPALITY
9	If the voter is unable to sign his or her name, the voter shall make his or her mark, which mark shall be witnessed. The signature, name and residence of the registered voter in the State of New Jersey who filled out this form are:	
9	SIGNATURE	DATE
9	NAME (Please Print)	COUNTY ZIP
9	STREET ADDRESS	MUNICIPALITY

FOLD ALONG THIS LINE BEFORE SEALING

0004 / 00095

IMPORTANTE: INSTRUCCIONES

Favor de leer con cuidado antes de llenar forma

1. Artículos 1, 2, 3, 4, 6 y 7 tienen que ser llenados por completo. Llene el artículo no. 5 solamente si usted se ha registrado anteriormente.
2. Artículo 8 tiene que ser firmado por un votante registrado en el estado de Nueva Jersey.
3. LAS DOS FORMAS TIENEN QUE LLENARSE.

NOTA: Si un solicitante es incapaz de firmar su nombre, una señal tiene que ponerse en la línea marcada "Firma O Señal" en la línea 7, entonces la persona que llena la tarjeta también tiene que llenar el artículo 8.

DESPEGUE EL PANEL DE INSTRUCCIONES A LO LARGO DE LA LÍNEA DE PUNTOS ANTES DE, ECHAR LA FORMA AL CORREO.

FORMA de REGISTRACION

FAVOR DE IMPRIMIR O RECARROGRAFAR

1	Nombre	Fecha de Nacimiento	
2	APELLIDO	NOMBRE	MESES DIA AÑO
3	Residencia		
4	CALLE	NUMERO DE APT	MUNICIPIO
5	He resultado en dicha direccion desde	CONDADO	ZIP
6	MESES DIA AÑO	Donde se registró ultimo para votar?	
7	CALLE	NUMERO DE APT	MUNICIPIO
8	CONDADO	ESTADO	ZIP
9	Yo soy un ciudadano (escoga uno) <input type="checkbox"/> natural <input type="checkbox"/> naturalizado	Fui naturalizado	
10	MESES DIA AÑO	MUNICIPIO	ESTADO
11	Al tiempo de la proxima eleccion general, tendré por lo menos 18 años de edad, seré ciudadano de los Estados Unidos, y habré resultado en este estado por lo menos 30 días y en el condado de _____ por lo menos 30 días. Según mi fiel saber y entender, todas las declaraciones anteriores hechas por mí son ciertas. Comprendo que cualquiera registración o autentica registración, más puede someterme a una multa hasta \$1,000 o encarcelación hasta 6 años o ambas, de acuerdo con R.S. 1924-1		
12	FRMA O SEÑAL	FECHA	
13	Yo, siendo un votante registrado en el condado de _____ en el estado de Nueva Jersey, he presentado dicha firma o señal		
14	FRMA	FECHA	
15	NOMBRE (FAVOR DE IMPRIMIR)		
16	CALLE	MUNICIPIO	CONDADO, ZIP
17	Si un votante es incapaz de firmar su nombre, el votante hará su señal, cual señal será presentado. La firma, nombre y residencia del votante registrado en el estado de Nueva Jersey llenado en esta forma son _____		
18	FRMA	FECHA	
19	NOMBRE (FAVOR DE IMPRIMIR)		
20	CALLE	MUNICIPIO	CONDADO, ZIP

DOBLE A LO LARGO DE ESTA LINEA ANTES DE SELLAR.

ESTA FALDETA ESTA ENGOMADA DOBLE LA FORMA EN MITAD, MOJE LA AREA ENGOMADA Y SELLELA.

FORMA de REGISTRACION

FAVOR DE IMPRIMIR O RECARROGRAFAR

1	Nombre	Fecha de Nacimiento	
2	APELLIDO	NOMBRE	MESES DIA AÑO
3	Residencia		
4	CALLE	NUMERO DE APT	MUNICIPIO
5	He resultado en dicha direccion desde	CONDADO	ZIP
6	MESES DIA AÑO	Donde se registró ultimo para votar?	
7	CALLE	NUMERO DE APT	MUNICIPIO
8	CONDADO	ESTADO	ZIP
9	Yo soy un ciudadano (escoga uno) <input type="checkbox"/> natural <input type="checkbox"/> naturalizado	Fui naturalizado	
10	MESES DIA AÑO	MUNICIPIO	ESTADO
11	Al tiempo de la proxima eleccion general, tendré por lo menos 18 años de edad, seré ciudadano de los Estados Unidos, y habré resultado en este estado por lo menos 30 días y en el condado de _____ por lo menos 30 días. Según mi fiel saber y entender, todas las declaraciones anteriores hechas por mí son ciertas. Comprendo que cualquiera registración o autentica registración, más puede someterme a una multa hasta \$1,000 o encarcelación hasta 6 años o ambas, de acuerdo con R.S. 1924-1		
12	FRMA O SEÑAL	FECHA	
13	Yo, siendo un votante registrado en el condado de _____ en el estado de Nueva Jersey, he presentado dicha firma o señal		
14	FRMA	FECHA	
15	NOMBRE (FAVOR DE IMPRIMIR)		
16	CALLE	MUNICIPIO	CONDADO, ZIP
17	Si un votante es incapaz de firmar su nombre, el votante hará su señal, cual señal será presentado. La firma, nombre y residencia del votante registrado en el estado de Nueva Jersey llenado en esta forma son _____		
18	FRMA	FECHA	
19	NOMBRE (FAVOR DE IMPRIMIR)		
20	CALLE	MUNICIPIO	CONDADO, ZIP

APPENDIX F

IMPORTANT

The Name, Address and Designation of the Candidate on this petition must be printed or typed. If not complied with, petition will be returned to be properly filled out.

Nomination by Petition for Primary Election

TO THE HONORABLE COUNTY CLERK:

We, the undersigned, hereby certify that we reside in the County of Gloucester of the State of New Jersey, and that we are qualified voters therein; that we are members of the PARTY, and that at the last election for members of the General Assembly preceding the execution of this petition we voted for a majority of the candidates of the political party herein named, and that we intend to affiliate with the said party at the ensuing election; that we endorse the person hereinafter mentioned as candidate for nomination to the office therein named, and we request that you cause to be printed upon the official primary ballot of said party the name of said person as the candidate for such nomination.

We further certify that the office for which said person is named, the residence and post-office address of said person so endorsed is as follows (19-23-7):

Table with 4 columns: Office to Be Filled, Name of Candidate, Residence, P.O. Address. The table contains several rows of dotted lines for handwritten entry.

We further certify that the said person so endorsed is legally qualified under the laws of this State to be nominated for said office (19-23-7).

We do further certify that the names and post-office addresses of the three members named as a committee on vacancies are as follows (19-23-12):

Table with 3 columns: Name, Residence, P.O. Address. The table contains several rows of dotted lines for handwritten entry.

SIGNATURE SHEET

Signature and address must be written (not printed) in the signer's own handwriting:

Table for signatures with 3 columns: NAME, Number, Street or Avenue, City. It contains 18 numbered rows for individual signers.



THIS SET OF SIGNATURES IS ONLY PART OF A PETITION

*The witness taking the affidavit below must be the person who obtained the names on this set of signatures or several sets of signatures. They must take the affidavit as witness for each set they solicit. Although the signature sheets are solicited separately, the entire petition must be bound together before submitting to the County Clerk.

STATE OF NEW JERSEY
COUNTY OF GLOUCESTER } ss.

....., being duly sworn, upon his oath saith that he is one of the signers of the petition hereto annexed; that such petition is signed by each of the signers thereof in his own proper handwriting; that each of such signers are, to the best knowledge and belief of deponent, legal voters of the County of Gloucester of the State of New Jersey, as stated in said petition, and belong to the political party named in said petition, and that such petition is prepared and filed in absolute good faith for the sole purpose of endorsing the person or persons therein named in order to secure his or their nomination or selection as stated in said petition. (19:23-11.)

Subscribed and sworn to before me at

....., N. J., this
..... day of 19....

Candidate's Request for Designation on the Official Primary Ballot

The above candidate, having been endorsed for the office mentioned in this petition, does hereby request that there be printed opposite his name on the said primary ticket the following designation:

(Must not exceed six words). (19 23-17)

CERTIFICATE OF ACCEPTANCE

I, the undersigned, hereby certify that I am qualified for the office mentioned in said petition; that I am a member of the REPUBLICAN PARTY, the political party named herein; that I am a resident of and a legal voter in the jurisdiction of the office for which the nomination is to be made; that I consent to stand at the ensuing primary election and that if nominated I agree to accept the nomination.

Candidate's Signature

Candidate's Signature

Candidate's Signature

Candidate's Signature

Candidate's Signature

Candidate's Signature

OATH OF ALLEGIANCE

STATE OF NEW JERSEY
COUNTY OF GLOUCESTER } ss.

I, the undersigned, do solemnly swear (or affirm) that I will support the Constitution of the United States and the Constitution of the State of New Jersey, and that I will bear true faith and allegiance to the same and to the Governments established in the United States and in this State, under the authority of the people; and will defend them against all enemies, foreign and domestic, that I do not believe in, advocate or advise the use of force, or violence or other unlawful or unconstitutional means, to overthrow or make any change in the Government established in the United States or in this State, and that I am not a member of or affiliated with any organization, association, party, group or combination of persons, which approves, advocates, advises or practices the use of force, or violence, or other unlawful or unconstitutional means, to overthrow or make any change in either of the Governments so established, and that I am not bound by any allegiance to any foreign prince, potentate, state or sovereignty whatever. So help me God

Sworn to and subscribed to before me this

..... day of
A D 19

Candidate's Signature

Candidate's Signature

Candidate's Signature

Candidate's Signature

Candidate's Signature

Candidate's Signature

NOTICE
All candidates are required by law to comply with the provisions of the New Jersey Campaign Contributions and Expenditures Regulation Act, 1947, c. 1 to 4.

BIBLIOGRAPHY

Legislative aides for State Senators (at least two):

() - _____

() - _____

Legislative aides for Assemblymen (at least two):

() - _____

() - _____

U.S. Senators and legislative aides:

Aide

() - _____

Aide

List of County Board of Election offices:

U.S. Representative and-aide:

()-

Director, Elections Section, Department of State:

()-

Legislative Liaison, Commissioner's Office, Department of Education:

()-

President or Executive Secretary, Press Association:

()-

President or Executive Secretary, Broadcasters Association:

()-

President, State League of Women Voters:

()-

Chairman, Voter Services, League of Women Voters:

President, Local League of Women Voters:

Director, State Common Cause Office:

Director, Governmental Relations, State Education Association:

Executive Director, State School Boards Association:

President, State Education Association:

Director, State Bar Association:

() -

Director, State American Civil Liberties Union:

() -

Executive Director, Republican State Committee:

() -

State Chairman, Republican State Committee:

() -

Executive Director, Democratic State Committee:

() -

State Chairman, Democratic State Committee:

() -

County Chairman, Republican Committee:

()-

County Chairman, Democratic Committee:

()-

President, Young Democrats:

()-

President, Young Republicans:

()-

President of college and/or university political organization:

()-

Campaign managers (at least two):

()-

() -

Public relations experts-campaigning (at least two):

() -

() -

B. ORGANIZATIONAL RESOURCES

American Public Research Council
3123 Washington Boulevard
Arlington, Virginia 22201

(703) 524-4343

Center for the Study of Responsive Law
P.O. Box 19367
Washington, D.C. 20036

(202) 833-3400

Common Cause
2100 M Street, N.W.
Washington, D.C. 20037

(202) 833-1200

People's Lobby
3456 W. Olympic Boulevard
Los Angeles, California 90010

(213) 731-8321

Frontlash
112 East 19th Street
New York, N.Y. 10003

(212) 228-4882

National Student Association
2115 S Street, N.W.
Washington, D.C. 20008

(202) 265-9890

Source
2115 S Street, N.W.
Washington, D.C. 20008

(202) 387-1145

Student NEA
1201 16th Street, N.W.
Washington, D.C. 20036

(202) 833-5525

Young Americans for Responsible Action
529 14th Street, N.W.
Washington, D.C. 20045

(202) 347-1118

American Bar Association,
Young Lawyers' Section
1155 East 60th Street
Chicago, Illinois 60637

(312) 493-0533

Americans for Constitutional Action
955 L'Enfant Plaza North, S.W.
Washington, D.C. 20024

(202) 484-5525

Americans for Democratic Action
1424 16th Street, N.W.
Washington, D.C. 20036

(202) 265-5771

Committee on Political Education (COPE)
815 16th Street, N.W.
Washington, D.C. 20006

(202) 637-5000

The League of Women Voters of the United States
1730 M Street, N.W.
Washington, D.C. 20036

(202) 296-1770

Democratic National Committee
2600 Virginia Avenue, N.W.
Washington, D.C. 20037

(202) 333-8750

Republican National Committee
310 First Street, S.E.
Washington, D.C. 20003

(202) 484-6500

American Friends Service Committee
on National Legislation
1822 R Street, N.W.
Washington, D.C. 20009

(202) 232-3196

National Council for the Social Studies
1201 16th Street, N.W.
Washington, D.C. 20003

(202) 833-4476

Access
1346 Connecticut Avenue, N.W.
Suite-526
Washington, D.C. 20036

(202) 466-8407

C. SUGGESTED READINGS

- AFL-CIO. *Critical Path Method*. AFL-CIO, Committee on Political Education, Washington, D.C.
- Andorian, Charles F. *Children and Civic Awareness: A Study in Political Awareness*. Chase and Merrill, Columbus, Ohio, 1971.
- Barber, James D. *Citizen Politics: An Introduction to Political Behavior*, 2nd ed.: Markham Publishing Company, Chicago, 1972.
- Barber, James D. *Power to the Citizen*. Markham Publishing Company, Chicago, 1969.
- Bone, Hugh A. *American Politics and the Party System*. McGraw-Hill Book Company, New York, 1971.
- Burnham, Walter C. *Critical Elections and the Mainsprings of American Politics*. Norton, New York, 1970.
- Campbell, A. *The American Voter*. John Wiley & Sons, Inc., New York, 1960.
- deGrazia, Alfred. "Political Behavior," Vol. I, *Politics and Government*. Collier Books, New York, 1962.
- DeVries, Walter and Lance Tarrance. *The Ticket-Splitters: A New Force in American Politics*. William B. Eerdman's Publishing Company, Grand Rapids, Michigan, 1972.
- Gillespie, Judith A., and John J. Patrick. *Comparing Political Experiences*. The American Political Science Association, Washington, D.C., 1974.
- Greenstein, Fred J. *The American Party System and the American People*. Prentice Hall, Inc., Englewood Cliffs, N.J., 1963.
- Hanson, Robert W., and Robert Booth. *Obligation and Dissent: An Introduction to Politics*. Little, Brown and Company, Boston, 1971.
- Herzberg, Donald. "Who, Me a Politician?", *Grass Roots Guides*. The Center for Information on America, Washington, Conn., 1964.
- Holler, Frederick L. *The Information Sources of Political Science*. American Bibliographic Center Clio Press, Santa Barbara, California, 1971.
- Jayner, Conrad. *The American Politician*. The University of Arizona Press, Tucson, Arizona, 1971.
- Keniston, Kenneth. *The Uncommitted*. Harcourt, Brace and World, Inc., New York, 1965.
- Keniston, Kenneth. *Young Radicals*. Harcourt, Brace and World, Inc., New York, 1968.
- Key, V. O. *Politics, Parties, and Pressure Groups*. 5th ed.; T. Y. Crowell Company, New York, 1968.
- Kornhouser, William. *The Politics of Mass Society*. The Free Press, Glencoe, Illinois, 1959.
- Lane, Robert E., James D. Barber, and Fred J. Greenstein. *An Introduction to Political Analysis*, Prentice Hall Inc., Englewood Cliffs, N.J., 1967.
- League of Women Voters of New Jersey. *Choosing the President*. LWV, Montclair, N.J., 1972.
- League of Women Voters of New Jersey. *Political Parties in New Jersey*. LWV, Montclair, N.J., 1971.
- League of Women Voters. *Voting in New Jersey*. LWV, Montclair, N.J., 1974.

- Mellinger, Howard D. *Making Political Decisions*. Social Studies Development Center, Indiana University, Bloomington, Indiana, 1973.
- Mehlinger, Howard D., and John J. Patrick. *American Political Behavior*. Ginn and Company, Lexington, Massachusetts, 1972.
- Mitchell, W. C. *Why Vote?* Markham Publishing Company, Chicago, 1971.
- Munger, Frank, and Douglas Price. *Readings in Political Parties and Pressure Groups*. T. Y. Crowell Company, New York, 1967.
- National Education Association. *A Manual for Precinct Workers*. NEA Division of Government Relations, Washington, D.C., 1973.
- New Jersey Education Association. "NJEAC PAC" material. NJEA, Trenton, N.J.
- New Jersey Republican State Committee. *Mission 70's*. "N.J. Republican Voting District Manual." N.J. Republican State Committee, Trenton, N.J., 1968.
- Nimmo, Dan. *The Political Persuaders*. Prentice-Hall, Inc., Englewood Cliffs, N.J., 1970.
- Orum, Anthony M. *The Seeds of Politics*. Prentice-Hall, Inc., Englewood Cliffs, N.J., 1972.
- Patrick, John J., and Allen D. Glenn. *The Young Voter*. National Council for the Social Studies, Washington, D.C., 1972.
- Phillips, K. *The Emerging Republican Majority*. Anchor Book Company, Garden City, N.Y., 1970.
- Posey, Rollin B. *The Voter's Handbook*. Harper & Row, Publishers, Inc., New York, 1972.
- Roll, Charles W., Jr., and Albert H. Cantril. *Polls—Their Use and Misuse in Politics*. Basic Books, Inc., New York, 1972.
- Royko, Mike. *Boss: Richard J. Daley of Chicago*. E. P. Dutton and Company, Inc., New York, 1971.
- Walzer, Michael. *Political Action: A Practical Guide to Movement Politics*. Quadrangle/The New York Times Book Company, Chicago, 1971.

D. AUDIO/VISUALS

American Government Series, Pennsylvania State University, University Park, Penna. (films, 30 minutes each):

- "The Ethical Basis of Political Power"
- "Civil Rights and Social Democracy, the Right to Vote"
- "The Role of States in the American System of Government"
- "The Limits of Presidential Power"
- "Bicameralism-Numerical and Concurrent Majorities."

Changing the System. Zenger Productions, Inc., Culver City, California, 1972. (filmstrip and teacher's guide)

How to Use a Voting Machine. Institute for Political and Legal Education, Pitman, New Jersey, 1975. (filmstrip)

Analysis of Public Issues Program. Houghton Mifflin Company, Boston. (filmstrip, overlays, and teacher guide)

The Election Process. Doubleday Multimedia, Santa Ana, California, 1974. (filmstrip series and teacher guide)

The New Age of Majority. Institute for Political and Legal Education, Pitman, New Jersey, 1975. (filmstrip)

Voter Registration and Rights. Institute for Political and Legal Education, Pitman, New Jersey, 1975.

E. SIMULATIONS

American Government Simulations Series, Science Research Associates, Inc., Chicago, Illinois, 1969:

- "The American Constitutional Convention"
- "Presidential Election Campaigning"
- "Decision-Making by Congressional Committees"
- "Budgetary Politics and Presidential Decision-Making"
- "The Congressman at Work"

OBITUARY

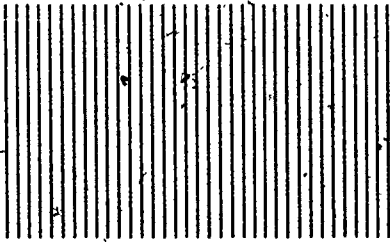

**HEADLINES
OTHER
THAN DEATHS**

7 A

XX
XX HEAD XX
XX XX

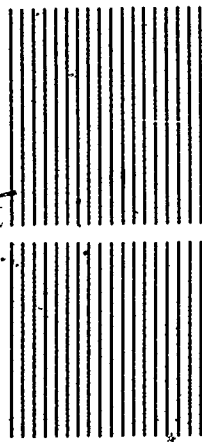

XX
XX HEAD XX
XX XX

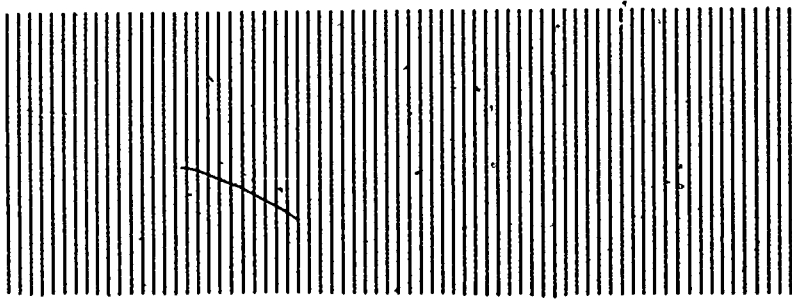

b

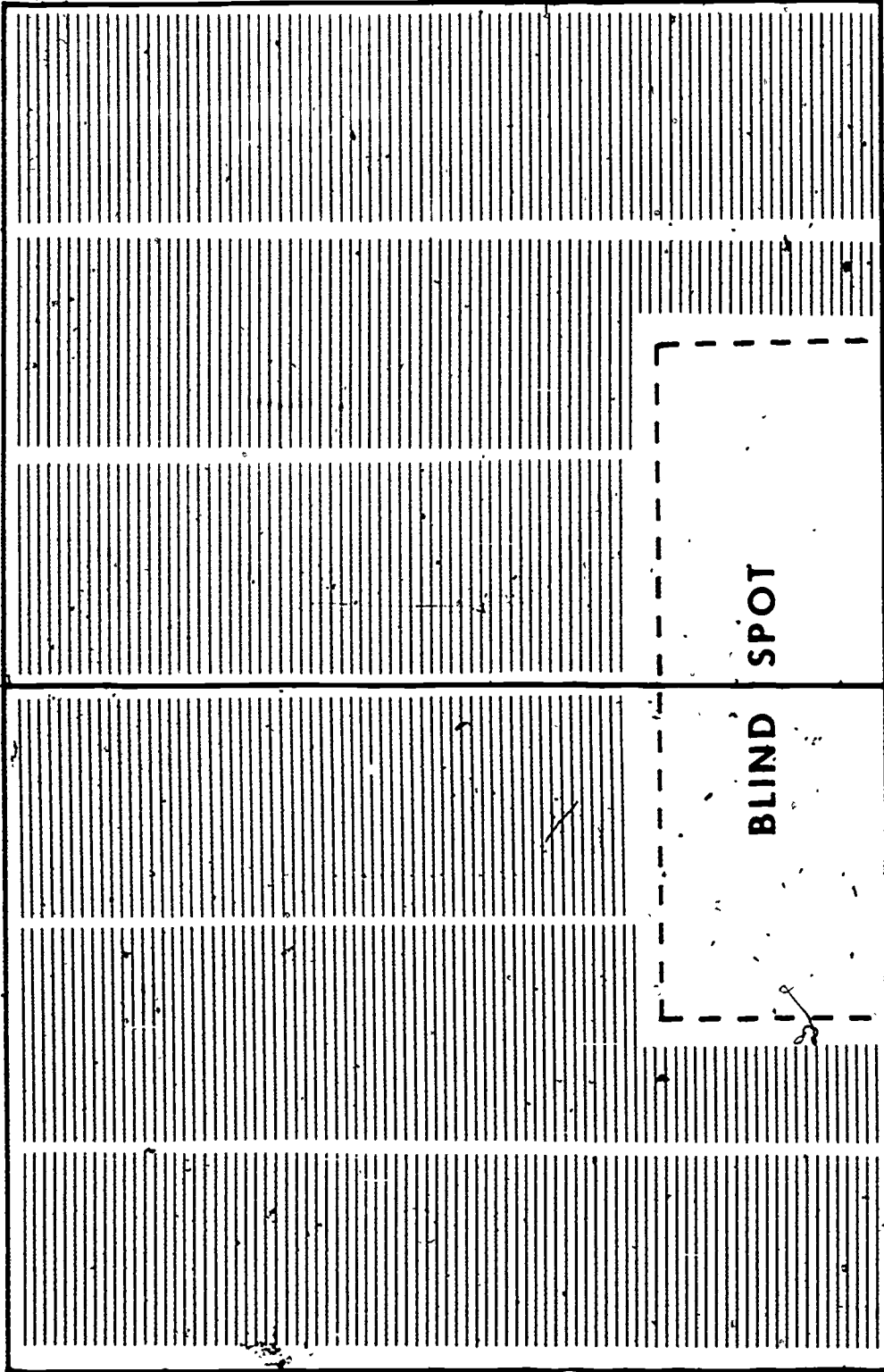

C

P

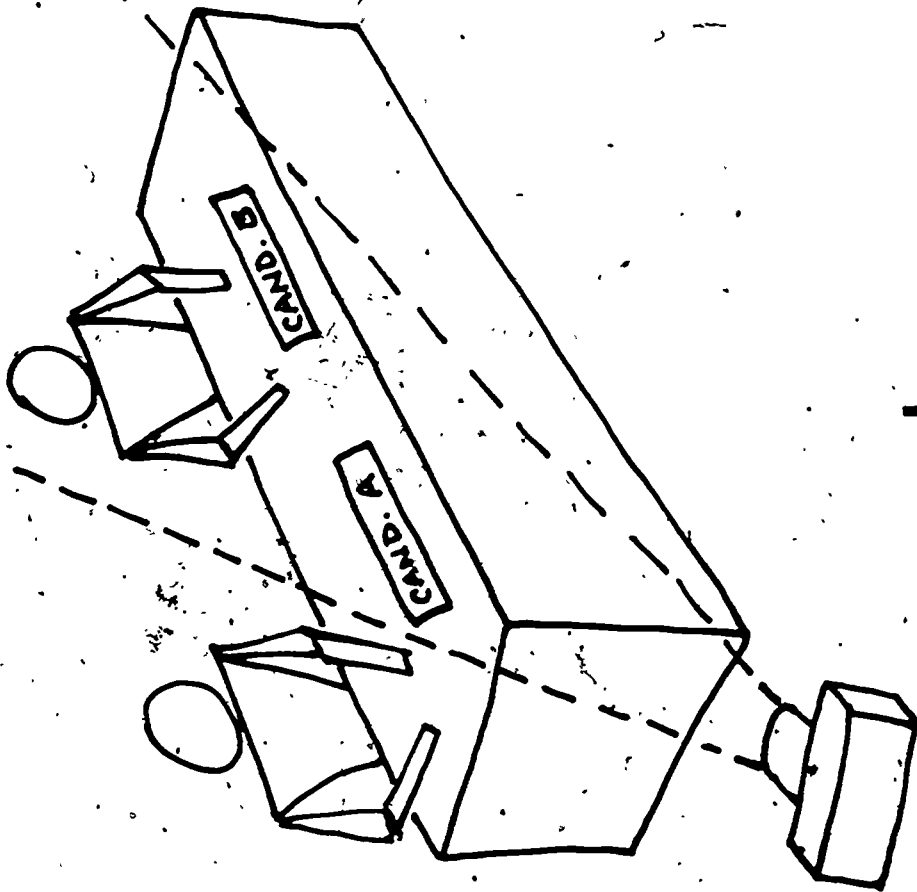

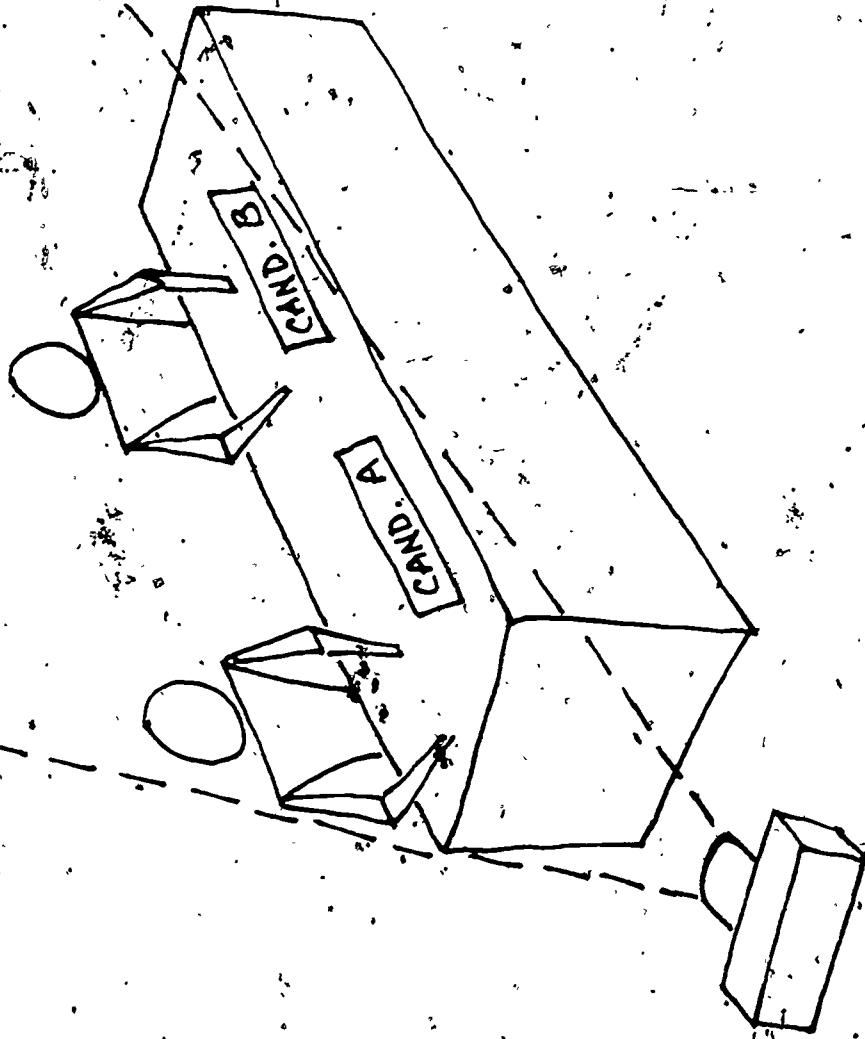

E



f

CANDIDATE FACES
UNRULY CROWD

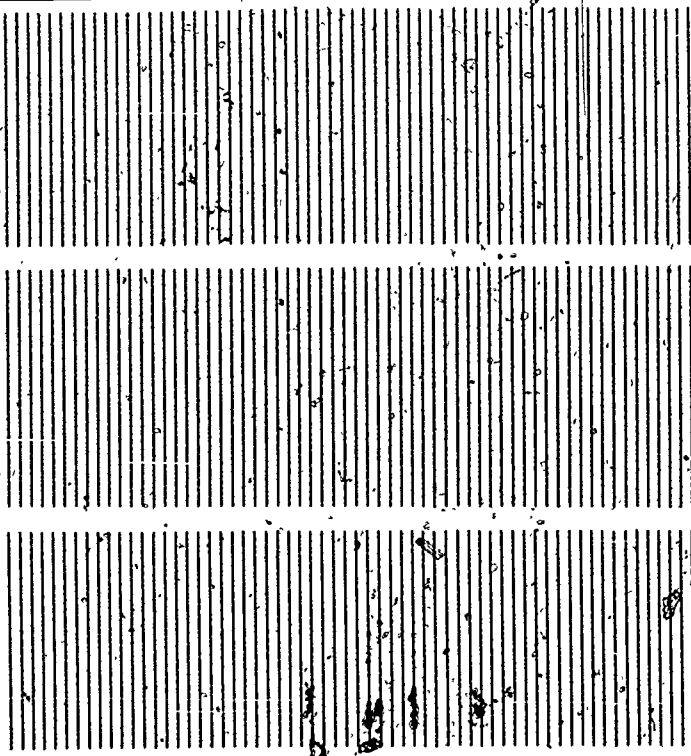

9

118

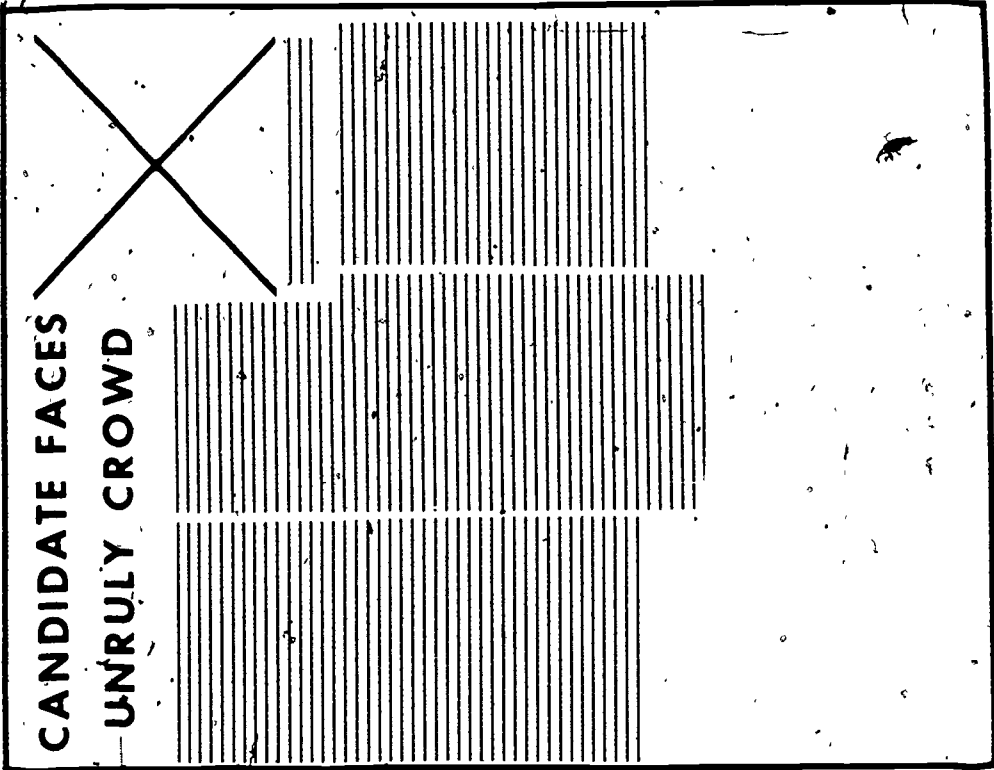

H

119

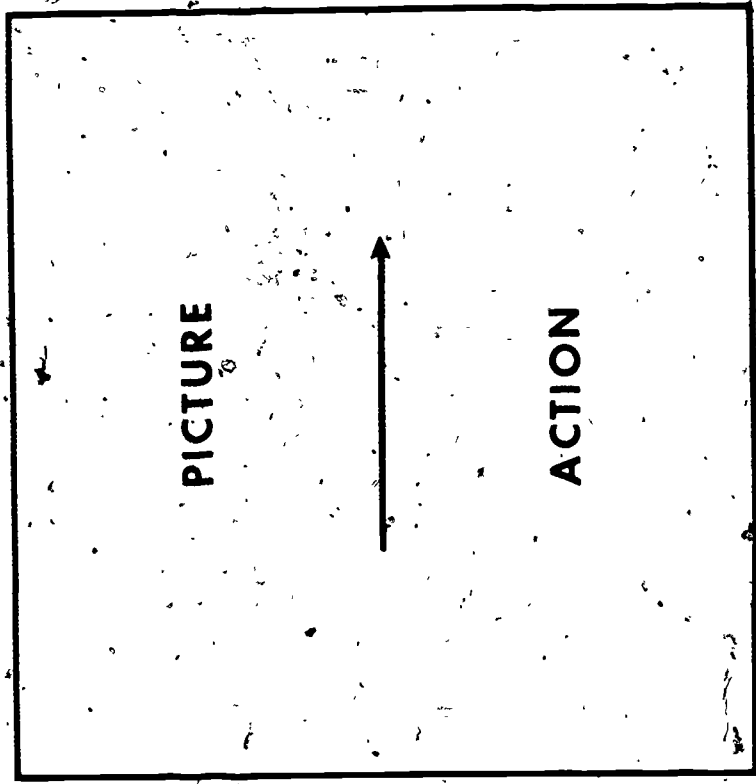

BLIND SPOT



i

120